









INDICE PRODOTTO - PRODUCT INDEX

Prodotto - Product	Sez - Sect	Pag.
--------------------	------------	------





ACCESSORI - ACCESSORIES

	POSACENERE - ASHTRAYS	1.1	1
	MANIGLIE - HANDLES	1.3	4
	TAVOLINI - TABLES	1.4	26
	RETINE - MAGAZINE NETS	1.5	37
	PORTABICCHIERI - CUPHOLDERS	1.6	50
	APPOGGIAPIEDI - FOOTRESTS	1.7	54
	BRACCIOLI - ARMRESTS	1.8	69
	GANCI FERMA TENDINE - CURTAINS HOLDERS	1.11	80

DISCHI COPRIRUOTA - WHEEL COVERS

	DISCHI IN ACCIAIO - STAINLESS STEEL WHEEL COVERS	2.1	82
	DISCHI IN PLASTICA - PLASTIC WHEEL COVERS	2.2	99
	DISCHI ED ANELLI COPRIMOZZO - HUB COVERS AND RINGS	2.3	114
	COPRIBULLONI - NUT COVERS	2.4	122

Posaceneri C - Ashtrays C

	MATERIAL	PC-ABS
	COLOR	BLACK ●
	MIN. ORDER	176 pcs
	UNIT	44 pcs
	WEIGHT	0,230 kg



6018305

Posaceneri C con vaschetta estraibile, montaggio mediante viti

Ashtray C with removable tray, fixing by screws



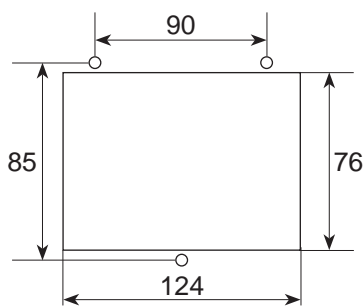

R118 ON DEMAND

DIMA DI FORATURA DRILL TEMPLATE

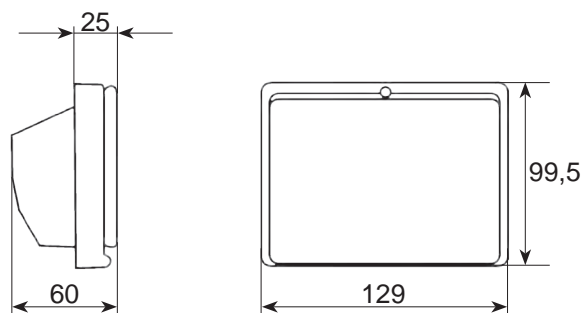

DIMENSIONI - DIMENSIONS



	MATERIAL	PC-ABS
	COLOR	BLACK ●
	MIN. ORDER	176 pcs
	UNIT	44 pcs
	WEIGHT	0,230 kg



6017355

Posaceneri C con vaschetta estraibile, montaggio a scatto

Ashtray C with removable tray, clip-in fixing

R118 ON DEMAND

DIMA DI FORATURA DRILL TEMPLATE

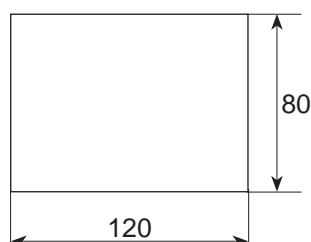



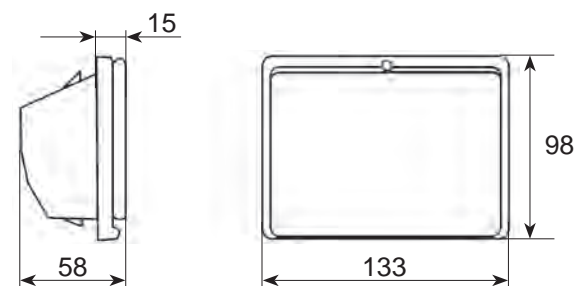

Spessore parete: max 5 mm
Wall thickness: max 5 mm

DIMENSIONI - DIMENSIONS



Posaceneri F - Ashtrays F

	MATERIAL	PC-ABS
	COLOR	BLACK ●
	MIN. ORDER	180 pcs
	UNIT	45 pcs
	WEIGHT	0,138 kg



6014605

Posaceneri F con vaschetta estraibile, montaggio a scatto o a vite

Ashtray F with removable tray, fixed with screws or by clip-in

R118 ON DEMAND

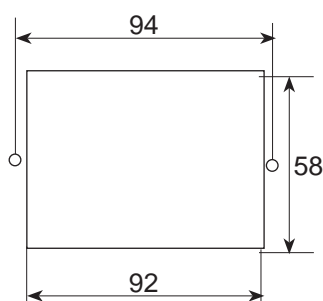

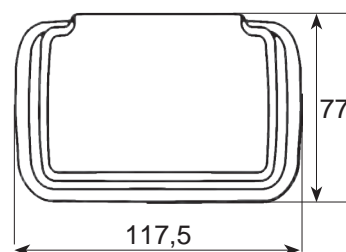
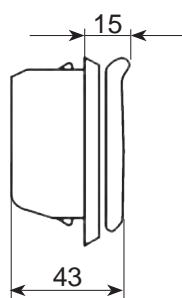

DIMA DI FORATURA
DRILL TEMPLATE

Spessore parete: max 5 mm
Wall thickness: max 5 mm

DIMENSIONI - DIMENSIONS



Accessori per modello F - Accessories for type F

	MATERIAL	ABS
	COLOR	BLACK ●
	MIN. ORDER	180 pcs
	UNIT	60 pcs
	WEIGHT	0,030 kg



6013945

Distanziale per posaceneri F per applicazione in piano

Spacer for on-wall fixings of ashtray F

DIMENSIONI - DIMENSIONS

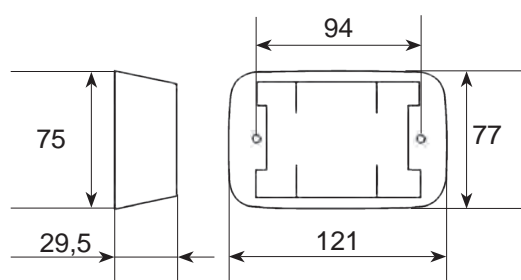

Portaoggetti amovibile - Movable holder



MATERIAL PC-ABS



COLOR BLACK ●



MIN. ORDER 200 pcs



WEIGHT 0,170 kg

601433B

ON DEMAND

Posacenere amovibile

Movable ashtray



DIMENSIONI - DIMENSIONS

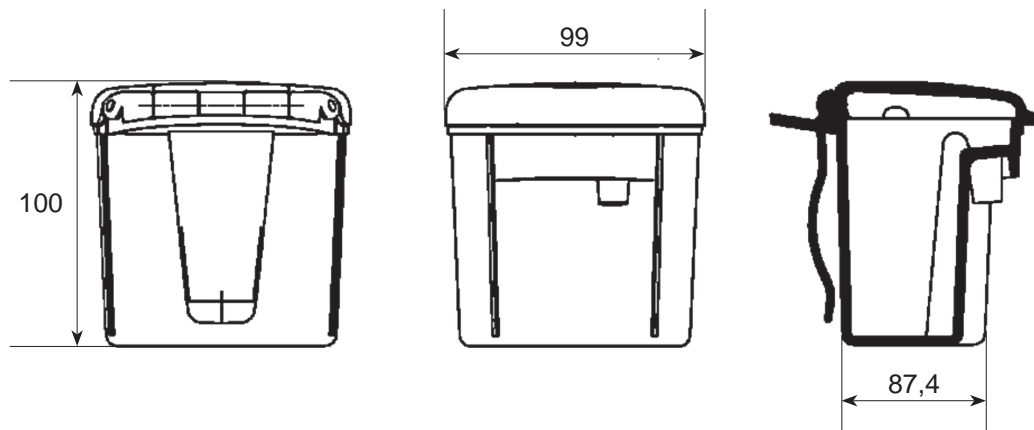

Maniglia A - "A" Handle



MATERIAL PP



COLOR BLACK ●



WEIGHT 0,038 kg



6030095

ON DEMAND

Maniglia A completa di tappi coprivite

Handle A with screw caps

DIMA DI FORATURA DRILL TEMPLATE

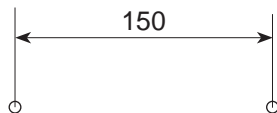



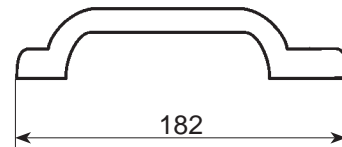
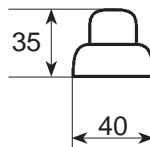

DIMENSIONI - DIMENSIONS



1.3

MANIGLIE - HANDLES

Maniglia Firenze - Firenze handle

	MATERIAL	PP
	COLOR	BLACK ●
	MIN. ORDER	180 pcs
	UNIT	60 pcs
	WEIGHT	0,075 kg





HOMOLOGATION R118

6037345

Maniglia rigida Firenze completa di tappi coprivite

Firenze rigid handle with screw caps

	MATERIAL	PP
	COLOR	GREY ●
	WEIGHT	0,075 kg





R118 ON DEMAND

6037341

ON DEMAND

Maniglia rigida Firenze completa di tappi coprivite

Firenze rigid handle with screw caps

	MATERIAL	PP
	COLOR	YELLOW ●
	WEIGHT	0,075 kg



HOMOLOGATION R118

6037344

ON DEMAND

Maniglia rigida Firenze completa di tappi coprivite

Firenze rigid handle with screw caps



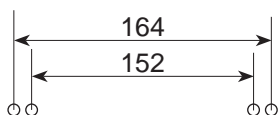

DIMA DI FORATURA
DRILL TEMPLATE

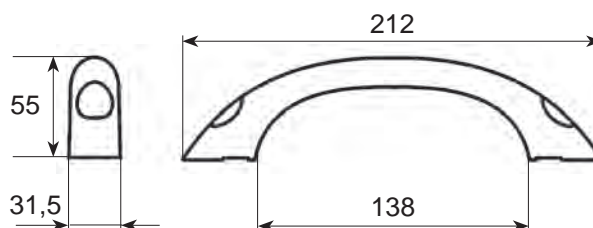

DIMENSIONI - DIMENSIONS



Accessori per maniglia Firenze - Accessories for Firenze handle

	MATERIAL	PP
	COLOR	BLACK/GREY/YELLOW
	MIN. ORDER	250 pcs
	UNIT	250 pcs
	WEIGHT	0,002 kg



6037305

Tappo coprivite specifico per maniglia Firenze

Screw cap for Firenze handle



6037301

Tappo coprivite specifico per maniglia Firenze

Screw cap for Firenze handle



6037304

Tappo coprivite specifico per maniglia Firenze

Screw cap for Firenze handle



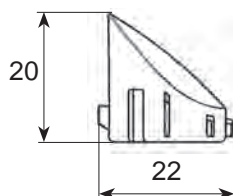

DIMENSIONI - DIMENSIONS



1.3

MANIGLIE - HANDLES

Maniglia Torino - Torino handle

	MATERIAL	PP
	COLOR	BLACK ●
	MIN. ORDER	180 pcs
	UNIT	60 pcs
	WEIGHT	0,076 kg







HOMOLOGATION R118

603764B

Maniglia morbida Torino completa di tappi coprivite

Torino handle soft touch with screw caps



	MATERIAL	PP
	COLOR	GREY ●
	MIN. ORDER	180 pcs
	UNIT	60 pcs
	WEIGHT	0,076 kg





R118 ON DEMAND

603764M

Maniglia morbida Torino completa di tappi coprivite

Torino handle soft touch with screw caps



	MATERIAL	PP
	COLOR	YELLOW ●
	WEIGHT	0,076 kg



HOMOLOGATION R118

603764D

ON DEMAND

Maniglia morbida Torino completa di tappi coprivite

Torino handle soft touch with screw caps





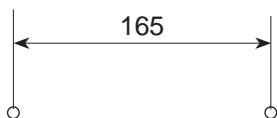

**DIMA DI FORATURA
DRILL TEMPLATE**

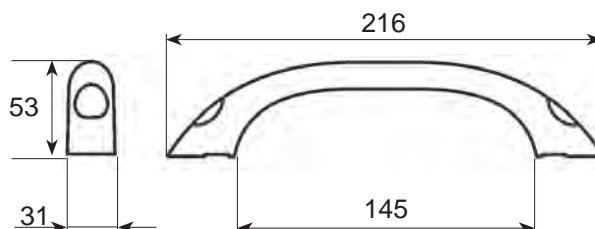

DIMENSIONI - DIMENSIONS



Maniglia Verona - Verona handle

	MATERIAL	PP
	COLOR	BLACK ●
	MIN. ORDER	180 pcs
	UNIT	60 pcs
	WEIGHT	0,090 kg





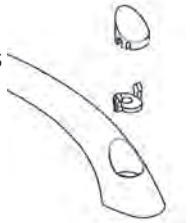

6037385

Maniglia morbida Verona completa di tappi coprivite

Verona handle soft touch with screw caps



	MATERIAL	PP
	COLOR	GREY ●
	MIN. ORDER	180 pcs
	UNIT	60 pcs
	WEIGHT	0,090 kg



6037381

Maniglia morbida Verona completa di tappi coprivite

Verona handle soft touch with screw caps





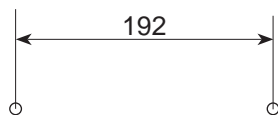

DIMA DI FORATURA DRILL TEMPLATE

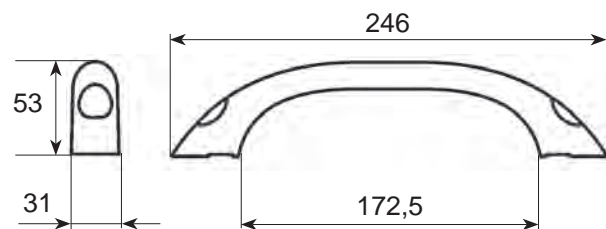

DIMENSIONI - DIMENSIONS



Accessori per maniglia Verona - Accessories for Verona handle

	MATERIAL	PP
	COLOR	BLACK/GREY
	MIN. ORDER	250 pcs
	UNIT	250 pcs
	WEIGHT	0,002 kg

DIMENSIONI - DIMENSIONS

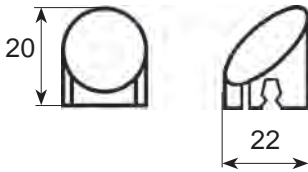
**603747B-SV**

Tappo coprivite specifico per maniglia Verona

Screw cap for Verona handle

**603747M-SV**

Tappo coprivite specifico per maniglia Verona

Screw cap for Verona handle

Maniglia tubolare - Hallow handle





8010615

Maniglia tubolare realizzata con iniezione a gas completa di tappi coprivite

Hallow handle manufactured with gas pressure technology, with screw caps



HOMOLOGATION R118

	MATERIAL	PP
	COLOR	BLACK ●
	MIN. ORDER	180 pcs
	UNIT	180 pcs
	WEIGHT	0,085 kg



8010614

ON DEMAND

Maniglia tubolare realizzata con iniezione a gas completa di tappi coprivite

Hallow handle manufactured with gas pressure technology, with screw caps



	MATERIAL	PP
	COLOR	YELLOW ●
	WEIGHT	0,085 kg



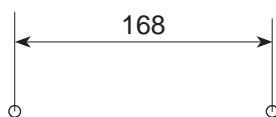

DIMA DI FORATURA DRILL TEMPLATE

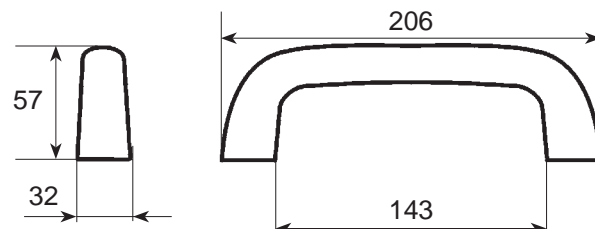

DIMENSIONI - DIMENSIONS



Accessori per maniglia tubolare - Accessories for hallow handle

	MATERIAL	PP
	COLOR	BLACK/YELLOW
	MIN. ORDER	250 PCS
	UNIT	250 PCS
	WEIGHT	0,002 kg

**8010665**

Tappo coprivite specifico per maniglia tubolare

Screw cap for hallow handle

**8010664**



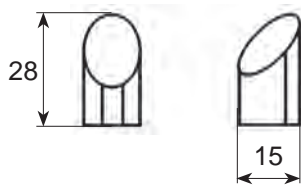

Tappo coprivite specifico per maniglia tubolare

Screw cap for hallow handle

DIMENSIONI - DIMENSIONS



Accessori per maniglia tubolare - Accessories for hallow handle

	MATERIAL	PA
	COLOR	BLACK ●
	MIN. ORDER	250 pcs
	UNIT	250 pcs
	WEIGHT	0,005 kg

**8010745**

Gancio appendiborse specifico per maniglia tubolare

Hook for hallow handle

DIMENSIONI - DIMENSIONS

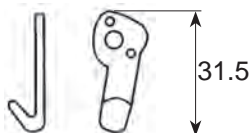

Maniglia Torino con inserto metallico - Torino handle with metal insert

6037275-MC

Maniglia morbida Torino con inserto metallico completa di tappi coprivite

Torino handle, soft touch with metal insert and screw caps

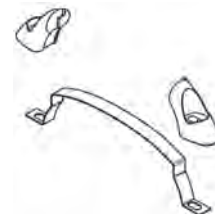

HOMOLOGATION R118

	MATERIAL	PP
	COLOR	BLACK ●
	MIN. ORDER	180 pcs
	UNIT	60 pcs
	WEIGHT	0,913 kg

6037270 - MC

Maniglia morbida Torino con inserto metallico completa di tappi coprivite

Torino handle, soft touch with metal insert and screw caps

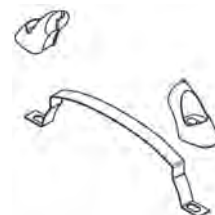

R118 ON DEMAND

	MATERIAL	PP
	COLOR	GREY ●
	MIN. ORDER	180 pcs
	UNIT	60 pcs
	WEIGHT	0,913kg

6037274-MC

Maniglia morbida Torino con inserto metallico completa di tappi coprivite

Torino handle, soft touch with metal insert and screw caps

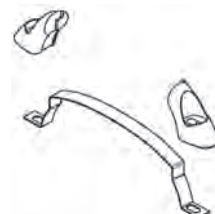

HOMOLOGATION R118

	MATERIAL	PP
	COLOR	YELLOW ●
	MIN. ORDER	180 pcs
	UNIT	60 pcs
	WEIGHT	0,913 kg



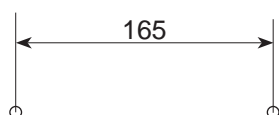

DIMA DI FORATURA DRILL TEMPLATE

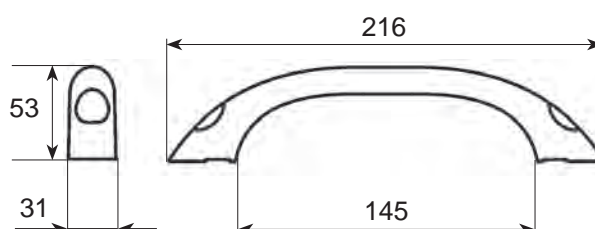

DIMENSIONI - DIMENSIONS



Accessori per maniglia Torino - Accessories for Torino handle

	MATERIAL	PP
	COLOR	BLACK/GREY/YELLOW
	MIN. ORDER	250 pcs
	UNIT	250 pcs
	WEIGHT	0,002 kg

**6037305**

Tappo coprivite specifico per maniglia Torino

Screw cap for Torino handle

**6037301**

Tappo coprivite specifico per maniglia Torino

Screw cap for Torino handle

**6037304**

Tappo coprivite specifico per maniglia Torino



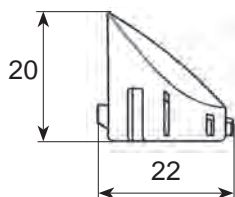

Screw cap for Torino handle

HOMOLOGATION R118

DIMENSIONI - DIMENSIONS



Maniglia lunga rigida - Long stiff handle

	MATERIAL	PP
	COLOR	BLACK ●
	MIN. ORDER	145 pcs
	UNIT	145 pcs
	WEIGHT	0,102 kg







HOMOLOGATION R118

6033415

Maniglia lunga, rigida realizzata con iniezione a gas completa di tappi coprivite

Long stiff handle manufactured with gas pressure technology, with screw caps

	MATERIAL	PP
	COLOR	YELLOW ●
	MIN. ORDER	145 pcs
	UNIT	145 pcs
	WEIGHT	0,102 kg





R118 ON DEMAND

603341D

Maniglia lunga, rigida realizzata con iniezione a gas completa di tappi coprivite

Long stiff handle manufactured with gas pressure technology, with screw caps

	MATERIAL	PP
	COLOR	GREY ●
	WEIGHT	0,102 kg



HOMOLOGATION R118

6033410

ON DEMAND

Maniglia lunga, rigida realizzata con iniezione a gas completa di tappi coprivite

Long stiff handle manufactured with gas pressure technology, with screw caps



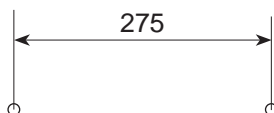

DIMA DI FORATURA DRILL TEMPLATE

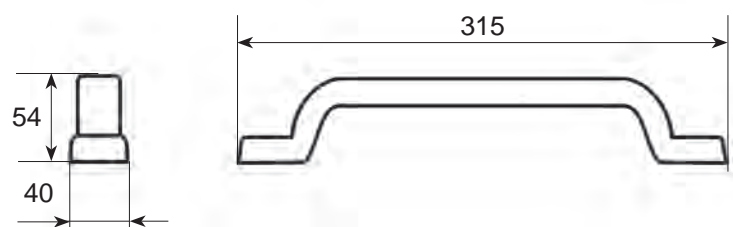

DIMENSIONI - DIMENSIONS



Accessori per maniglie lunghe - Accessories for long handles

	MATERIAL	PP
	COLOR	BLACK ●
	MIN. ORDER	250 pcs
	UNIT	250 pcs
	WEIGHT	0,006 kg

**6020085**





Gancio appendiborse
specifico per maniglie:

Hook for handles:

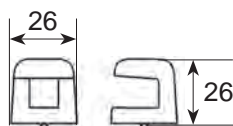
6030095, 6030195, 6030585,
6030795, 6032095, 6032145,
6033245, 6033255, 6033415,
6034195, 603246B

DIMENSIONI - DIMENSIONS



	MATERIAL	PP
	COLOR	BLACK/YELLOW
	MIN. ORDER	250 pcs
	UNIT	250 pcs
	WEIGHT	0,002 kg

**6030475**

Tappo coprivite per maniglia:

Screw cap for handles:



6030095, 6030195, 6030585,
6030795, 6032095, 6032145,
6033245, 6033255, 6033415,
6034195

603047D

Tappo coprivite per maniglia:
603341D

Screw cap for handles:
603341D



	MATERIAL	PP
	COLOR	BLACK ●
	WEIGHT	0,002 kg

**6031475****ON DEMAND**



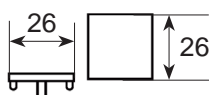

Tappo coprivite gofrato per maniglia:
603246B

Embossed screw cap for handles:
603246B

DIMENSIONI - DIMENSIONS



Maniglia Design piccola - Small handle Design

	MATERIAL	PP
	COLOR	BLACK ●
	MIN. ORDER	200 pcs
	UNIT	50 pcs
	WEIGHT	0,400 kg







603785B

Maniglia Design piccola con armatura metallica. Rivestimento in plastica morbida completa di tappi coprivite

Small handle Design with metal insert, soft plastic covering and screw caps

HOMOLOGATION R118

	MATERIAL	PP
	COLOR	GREY ●
	MIN. ORDER	200 pcs
	UNIT	50 pcs
	WEIGHT	0,400 kg





603785M

Maniglia Design piccola con armatura metallica. Rivestimento in plastica morbida completa di tappi coprivite

Small handle Design with metal insert, soft plastic covering and screw caps

R118 ON DEMAND

	MATERIAL	PP
	COLOR	YELLOW ●
	WEIGHT	0,400 kg



603785D

ON DEMAND

Maniglia Design piccola con armatura metallica. Rivestimento in plastica morbida completa di tappi coprivite

Small handle Design with metal insert, soft plastic covering and screw caps

HOMOLOGATION R118





DIMA DI FORATURA DRILL TEMPLATE

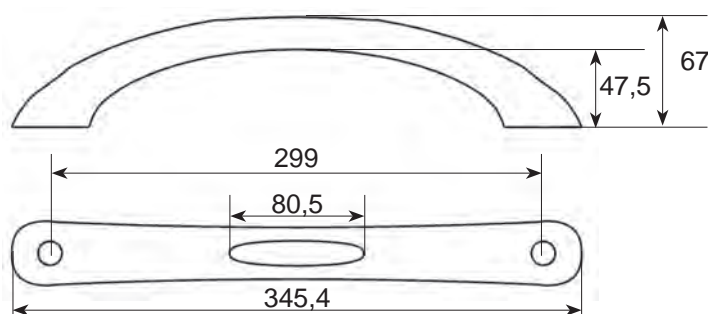

DIMENSIONI - DIMENSIONS



Maniglia Design grande - Large handle Design

	MATERIAL	PP
	COLOR	BLACK ●
	MIN. ORDER	200 pcs
	UNIT	40 pcs
	WEIGHT	0,55 kg







HOMOLOGATION R118

603784B

Maniglia Design grande con armatura metallica. Rivestimento in plastica morbida completa di tappi coprivite

Large handle Design with metal insert, soft plastic covering and screw caps

	MATERIAL	PP
	COLOR	GREY ●
	MIN. ORDER	200 pcs
	UNIT	40 pcs
	WEIGHT	0,55 kg





R118 ON DEMAND

603784M

Maniglia Design grande con armatura metallica. Rivestimento in plastica morbida completa di tappi coprivite

Large handle Design with metal insert, soft plastic covering and screw caps

	MATERIAL	PP
	COLOR	YELLOW ●
	WEIGHT	0,55 kg



603784D

ON DEMAND

Maniglia Design grande con armatura metallica. Rivestimento in plastica morbida completa di tappi coprivite

Large handle Design with metal insert, soft plastic covering and screw caps





DIMA DI FORATURA DRILL TEMPLATE

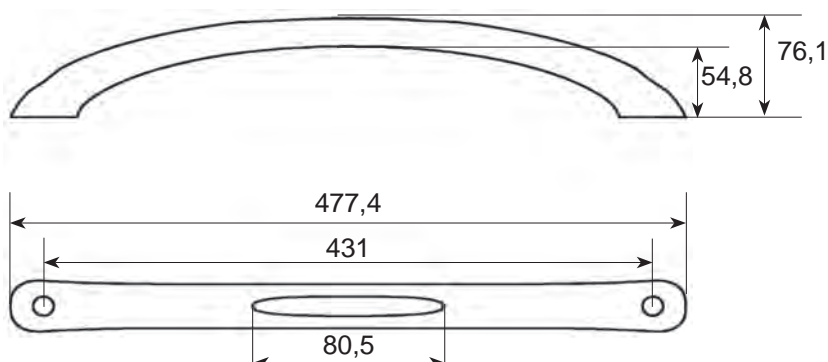

DIMENSIONI - DIMENSIONS



Maniglia Design piccola - Small handle Design

	MATERIAL	PA
	COLOR	BLACK ●
	MIN. ORDER	180 pcs
	UNIT	60 pcs
	WEIGHT	0,16 kg





603786B

Maniglia Design piccola in plastica rigida completa di tappi coprivite

Small handle Design in stiff plastic with screw caps

HOMOLOGATION R118

	MATERIAL	PA
	COLOR	GREY ●
	MIN. ORDER	180 pcs
	UNIT	60 pcs
	WEIGHT	0,16 kg







603786M

Maniglia Design piccola in plastica rigida completa di tappi coprivite

Small handle Design in stiff plastic with screw caps

HOMOLOGATION R118

	MATERIAL	PA
	COLOR	YELLOW ●
	MIN. ORDER	180 pcs
	UNIT	60 pcs
	WEIGHT	0,16 kg



603786D

Maniglia Design piccola in plastica rigida completa di tappi coprivite

Small handle Design in stiff plastic with screw caps

HOMOLOGATION R118



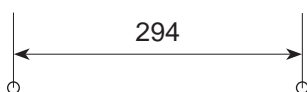

DIMA DI FORATURA DRILL TEMPLATE

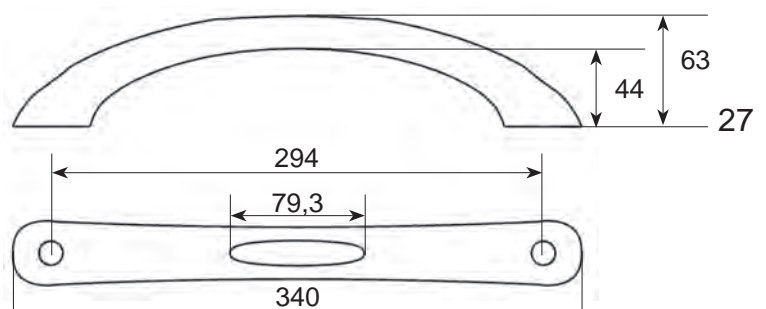

DIMENSIONI - DIMENSIONS



Accessori per maniglia Design - Accessories for Design handle

	MATERIAL	PA
	COLOR	BLACK/YELLOW
	MIN. ORDER	240 pcs
	UNIT	120 pcs
	WEIGHT	0,002 kg





HOMOLOGATION R118

603783BTappo coprivite per maniglie
603786B, 603785B, 603784BScrew cap for handles:
603786B, 603785B, 603784B

HOMOLOGATION R118

603783MTappo coprivite per maniglie
603786M, 603785M, 603784MScrew cap for handles:
603786M, 603785M, 603784M

	MATERIAL	PA
	COLOR	YELLOW ●
	WEIGHT	0,002 kg



HOMOLOGATION R118

603783D

ON DEMAND

Tappo coprivite per maniglie
603786D, 603785D, 603784DScrew cap for handles:
603786D, 603785D, 603784D

DIMENSIONI - DIMENSIONS

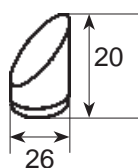

Etichetta per maniglie Design - Stiker for Design handle



MATERIAL SI



COLOR GREY/YELLOW



WEIGHT 0,001 kg



603790G

ON DEMAND

Etichetta per maniglie
603786B, 603785B, 603784B,
603786M, 603785M, 603784M

Stiker for handle 603.786.B,
603785B, 603784B, 603786M,
603785M, 603784M



603790D

ON DEMAND



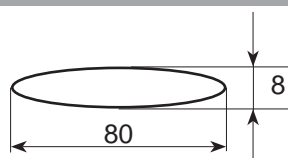

Etichetta per maniglie
603786B, 603785B, 603784B,
603786M, 603785M, 603784M

Stiker for handle 603.786.B,
603785B, 603784B, 603786M,
603785M, 603784M

DIMENSIONI - DIMENSIONS



Maniglione piccolo con armatura - Small handle with inlay

	MATERIAL	PP
	COLOR	BLACK ●
	MIN. ORDER	200 pcs
	UNIT	40 pcs
	WEIGHT	0,484 kg







HOMOLOGATION R118

6033225

Maniglione piccolo con armatura in alluminio e rivestimento in plastica morbida completa di tappi coprivite

Small handle with aluminum inlay, soft plastic covering and screw caps

	MATERIAL	PP
	COLOR	YELLOW ●
	MIN. ORDER	200 pcs
	UNIT	40 pcs
	WEIGHT	0,484 kg



R118 ON DEMAND

603322D

Maniglione piccolo con armatura in alluminio e rivestimento in plastica morbida completa di tappi coprivite

Small handle with aluminum inlay, soft plastic covering and screw caps

DIMA DI FORATURA DRILL TEMPLATE

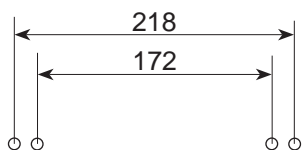

DIMENSIONI - DIMENSIONS

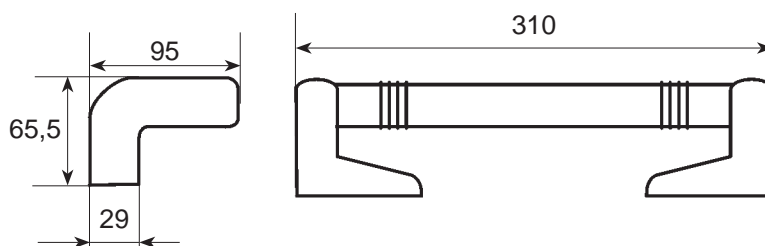

Maniglione grande con armatura - Large handle with inlay

6033205

Maniglia grande con armatura in alluminio e rivestimento in plastica morbida completa di tappi coprivite

Big handle with aluminum inlay, soft plastic covering and screw caps



HOMOLOGATION R118

	MATERIAL	PP
	COLOR	BLACK ●
	MIN. ORDER	180 pcs
	UNIT	45 pcs
	WEIGHT	0,654 kg

603320D

Maniglia grande con armatura in alluminio e rivestimento in plastica morbida completa di tappi coprivite

Big handle with aluminum inlay, soft plastic covering and screw caps



R118 ON DEMAND

	MATERIAL	PP
	COLOR	YELLOW ●
	MIN. ORDER	180 pcs
	UNIT	45 pcs
	WEIGHT	0,654 kg

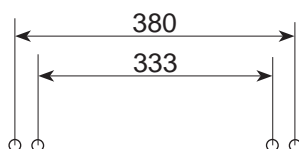

DIMA DI FORATURA DRILL TEMPLATE

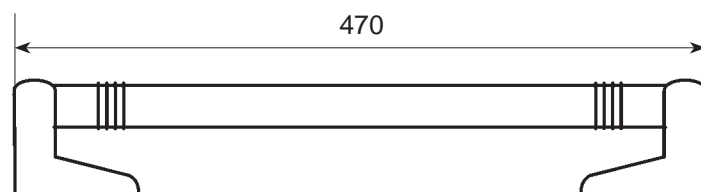
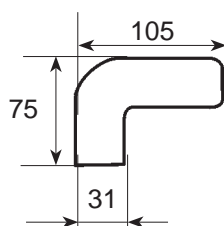

DIMENSIONI - DIMENSIONS



Accessori per maniglione con armatura - Accessories for handle with inlay

	MATERIAL	PP
	COLOR	BLACK/YELLOW
	WEIGHT	0,002 kg

**6032125****ON DEMAND**

Tappo coprivite gofrato per
maniglie 6033205, 6033225

Embossed screw cap for handles
6033205, 6033225

**603212D****ON DEMAND**



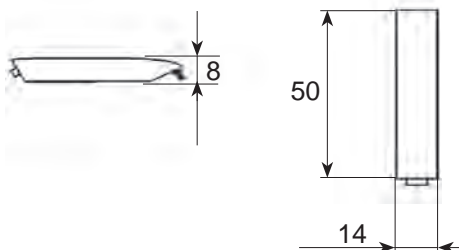

Tappo coprivite gofrato per
maniglie 603320D, 603322D

Embossed screw cap for handles
603320D, 603322D

DIMENSIONI - DIMENSIONS



Maniglia per sedile - Seat handle

	MATERIAL	PP
	COLOR	GREY ●
	MIN. ORDER	210 pcs
	UNIT	15 pcs
	WEIGHT	0,47 kg



HOMOLOGATION R118

800283C

Maniglia per sedile con perni di fissaggio
Seat handle with fixing pins

DIMENSIONI - DIMENSIONS

Prodotti costruiti in collaborazione con la ditta: Politecnica srl di Monsano (AN)

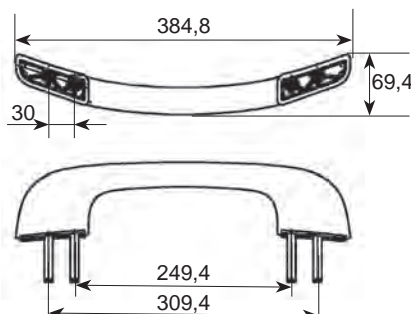

Design and engineering in collaboration with: Politecnica srl Monsano (AN), Italy



La distribuzione di questo articolo é soggetta a limiti territoriali. Vi preghiamo pertanto di verificare con il nostro ufficio commerciale la disponibilità dello stesso per la Vostra area geografica, prima di emettere l'ordine di acquisto

Distribution of this component is subject to territorial limits. We ask you kindly to check with our commercial department the availability of this component for your area prior to order submission

Poggiatesta - Headrest

	MATERIAL	PP
	COLOR	GREY ●
	WEIGHT	0,62 kg



HOMOLOGATION R118

800284C

ON DEMAND

Poggiatesta con perni di fissaggio
Headrest with fixing pins

DIMENSIONI - DIMENSIONS

Prodotti costruiti in collaborazione con la ditta: Politecnica srl di Monsano (AN)

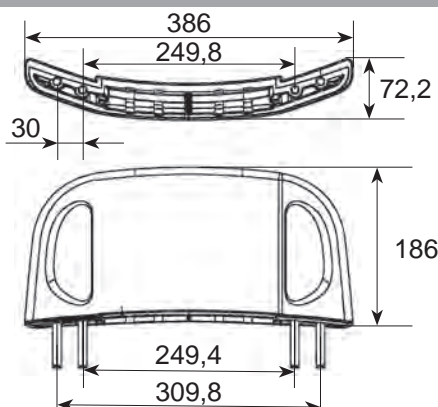

Design and engineering in collaboration with: Politecnica srl Monsano (AN), Italy



La distribuzione di questo articolo é soggetta a limiti territoriali. Vi preghiamo pertanto di verificare con il nostro ufficio commerciale la disponibilità dello stesso per la Vostra area geografica, prima di emettere l'ordine di acquisto

Distribution of this component is subject to territorial limits. We ask you kindly to check with our commercial department the availability of this component for your area prior to order submission

Poggiatesta con cuscino - Headrest with cushion

	MATERIAL	PP
	COLOR	GREY ●
	WEIGHT	0,42 kg



HOMOLOGATION R118

800299C**ON DEMAND**

Poggiatesta con cuscino e perni di fissaggio

Headrest with cushion and fixing pins

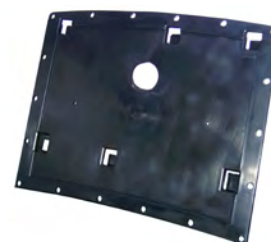

DIMENSIONI - DIMENSIONS

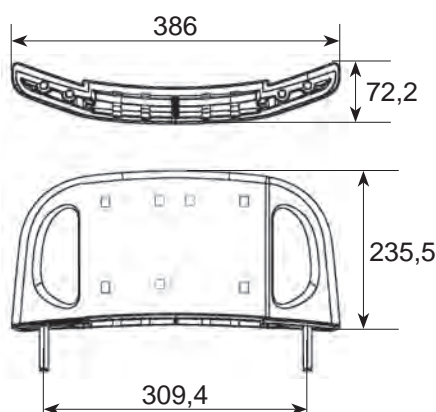
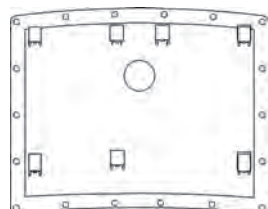

Prodotti costruiti in collaborazione con la ditta: Politecnica srl di Monsano (AN)

Design and engineering in collaboration with: Politecnica srl Monsano (AN), Italy

La distribuzione di questo articolo é soggetta a limiti territoriali. Vi preghiamo pertanto di verificare con il nostro ufficio commerciale la disponibilità dello stesso per la Vostra area geografica, prima di emettere l'ordine di acquisto







Distribution of this component is subject to territorial limits. We ask you kindly to check with our commercial department the availability of this component for your area prior to order submission

Tavolino TECHNO 120 - TECHNO 120 Table

6046125-2T

Tavolino TECHNO 120 con inserto metallico, inclinazione 25°
apertura verso il basso
antimicrobico ISO 22196:2011
con vano porta telefono
completo di cerniere

TECHNO 120 table with metal insert,
inclination 0°
Downwards opening
antimicrobial ISO 22196:2011
with telephone compartment
complete with hinges

	MATERIAL	PP
	COLOR	BLACK ●
	MIN. ORDER	150 pcs
	UNIT	25 pcs
	WEIGHT	0,520 kg
	COLLAPSE	12 kg



Completo di tappi coprivite
With screw caps

HOMOLOGATION R118

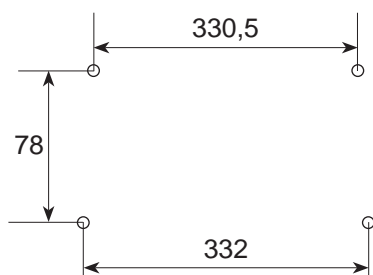
DIMA DI FORATURA
DRILL TEMPLATE

DIMENSIONI - DIMENSIONS

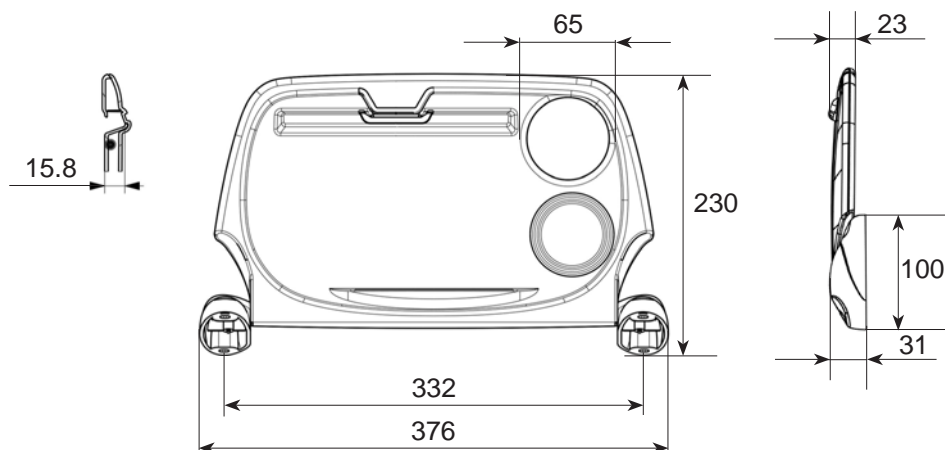

Caratteristiche tecniche - Technical features

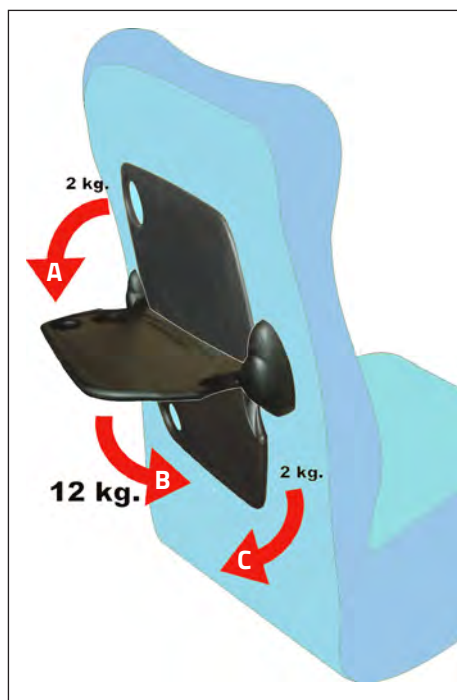

Il tavolino 120 realizzato in robusto materiale termoplastico adatto all'uso sui veicoli classificati a 4 stelle dove viene richiesta una sicurezza al collasso pari a 12 kg. Sono inoltre possibili svariate angolazioni da 0° a 25° gradi.







Varie possibilità di combinazione delle cerniere permettono l'applicazione su tutti i tipi di retroschienale.

Table type 120 is produced in a strong thermo-plastic material. This type of table is suitable for category class 4 vehicles, where, for security reasons, the collapsible load is equal to a weight of 12 kg.

Inclinations from 0° to 25°.
Several versions of hinges are available in order to be able to fit the table to different seat back configurations.

- A - Da riposo a utilizzo.
- From rest to working position.
- B - Collassamento per sicurezza.
- Safety collapse.
- C - Ritorno.
- Return.

Tavolino 120 - Table model 120

	MATERIAL	PP
	COLOR	BLACK ●
	MIN. ORDER	150 pcs
	UNIT	25 pcs
	WEIGHT	0,520 kg
	COLLAPSE	12 kg

**6046165**

Tavolino 120, inclinazione 0°
apertura verso il basso
completo di cerniere

120 table, inclination 0°
Downwards opening
complete with hinges

Completo di tappi coprivite
With screw caps

HOMOLOGATION R118

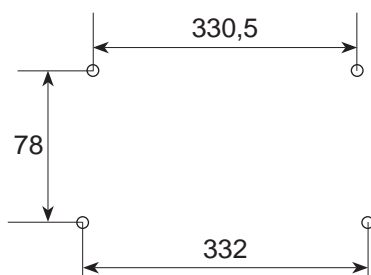
DIMA DI FORATURA
DRILL TEMPLATE

DIMENSIONI - DIMENSIONS

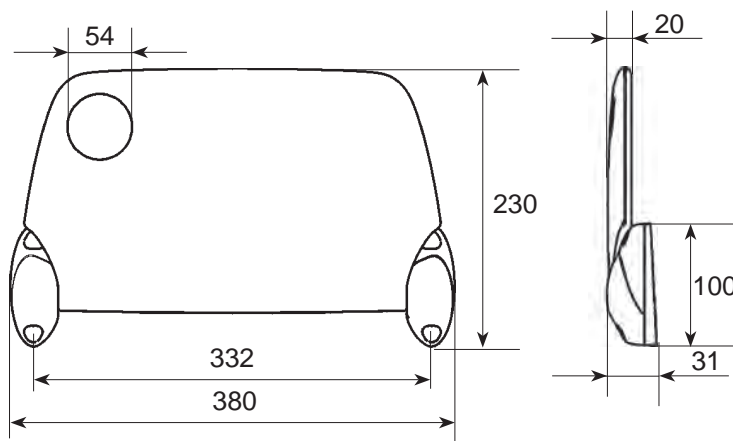

Tavolini con inclinazione variabile - Tables with variable inclination

6046105

Tavolino 120, inclinazione $\alpha = 15^\circ$

120 table, inclination $\alpha = 15^\circ$

6046125

Tavolino 120, inclinazione $\alpha = 25^\circ$

120 table, inclination $\alpha = 25^\circ$

6046145

Tavolino 120, inclinazione $\alpha = 35^\circ$

120 table, inclination $\alpha = 35^\circ$

6046115

Tavolino 120, inclinazione $\alpha = 20^\circ$

120 table, inclination $\alpha = 20^\circ$

6046135





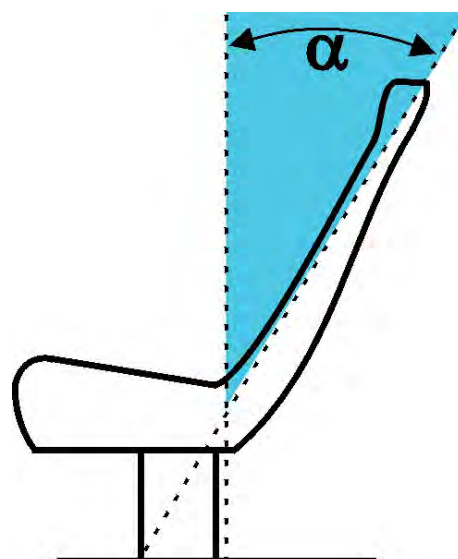

Tavolino 120, inclinazione $\alpha = 30^\circ$

120 table, inclination $\alpha = 30^\circ$

FIRE PROOF MATERIAL EN 45545-2
ON DEMAND



Tavolino 120 - Table model 120

	MATERIAL	PP
	COLOR	GREY ●
	MIN. ORDER	150 pcs
	UNIT	25 pcs
	WEIGHT	0,520 kg
	COLLAPSE	12 kg

**6046160**

Tavolino 120, inclinazione 0°
apertura verso il basso
completo di cerniere

120 table, inclination 0°
Downwards opening
complete with hinges

Completo di tappi coprivite
With screw caps

HOMOLOGATION R118

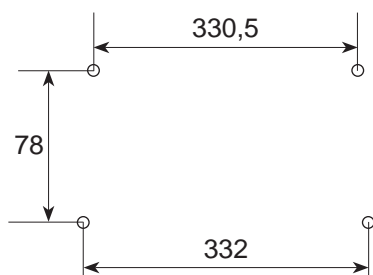
DIMA DI FORATURA
DRILL TEMPLATE

DIMENSIONI - DIMENSIONS

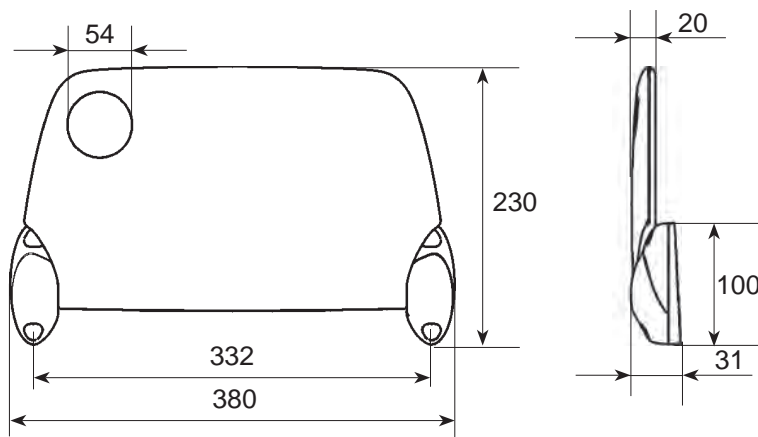

Tavolini con inclinazione variabile - Tables with variable inclination

6046100

Tavolino 120, inclinazione $\alpha = 15^\circ$

120 table, inclination $\alpha = 15^\circ$

6046120

Tavolino 120, inclinazione $\alpha = 25^\circ$

120 table, inclination $\alpha = 25^\circ$

6046140

Tavolino 120, inclinazione $\alpha = 35^\circ$

120 table, inclination $\alpha = 35^\circ$

6046110

Tavolino 120, inclinazione $\alpha = 20^\circ$

120 table, inclination $\alpha = 20^\circ$

6046130



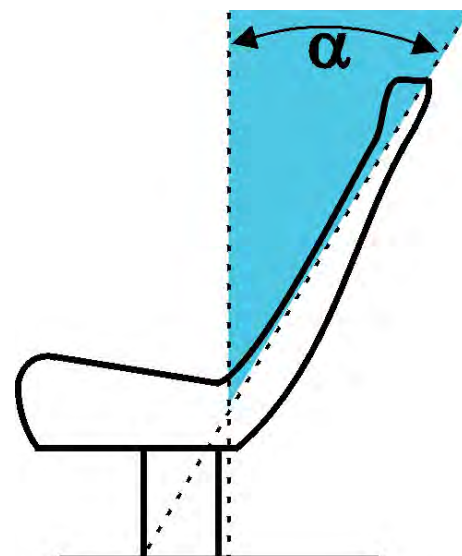

Tavolino 120, inclinazione $\alpha = 30^\circ$

120 table, inclination $\alpha = 30^\circ$

FIRE PROOF MATERIAL EN 45545-2
ON DEMAND



Tavolino 120/27° - Table 120/27°

	MATERIAL	PP
	COLOR	BEIGE ●
	WEIGHT	0,600Kg
	COLLAPSE	12 kg



604756Q

ON DEMAND

Tavolino 120 completo di cerniere e chiusura a rotazione, inclinazione 27°, apertura verso il basso

Table 120 with hinges and revolving loc-king device, inclination 27°, downwards opening

HOMOLOGATION R118

DIMA DI FORATURA DRILL TEMPLATE

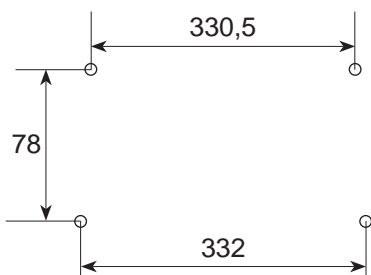

DIMENSIONI - DIMENSIONS

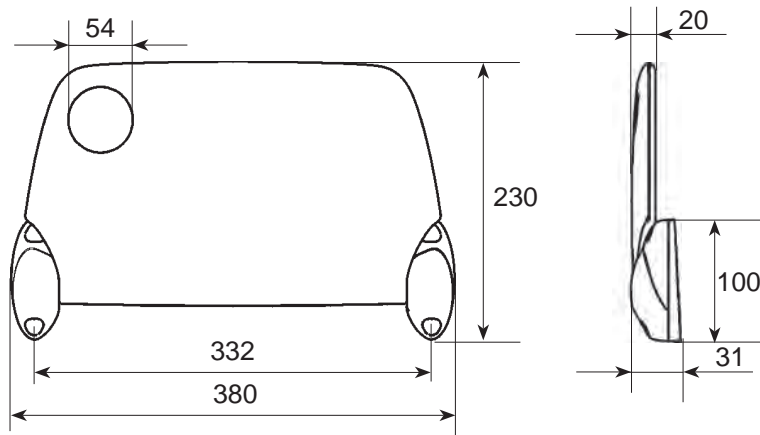

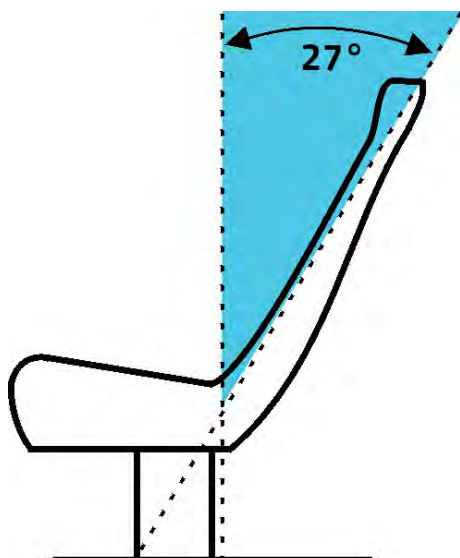

Inclinazione tavolino - Table inclination



Esempio chiusura Closing example



Kit cerniere - Hinge set

	MATERIAL	PA
	COLOR	BLACK/GREY
	WEIGHT	0,06 kg



604720B ON DEMAND

Kit composto da due cerniere, destra e sinistra

Right and left hand hinge set



604720M ON DEMAND

Kit composto da due cerniere, destra e sinistra

Right and left hand hinge set



DIMA DI FORATURA DRILL TEMPLATE

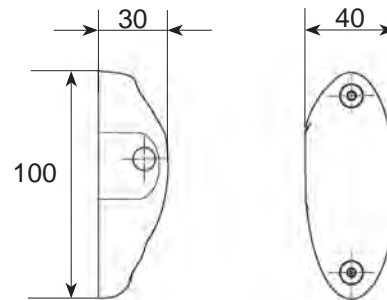

DIMENSIONI - DIMENSIONS



Kit tappi per cerniere - Caps kit for hinges

	MATERIAL	PA
	COLOR	BLACK/GREY
	WEIGHT	0,008 kg



604656B ON DEMAND

Kit 4 tappi per cerniera

Set of 4 caps





604656M ON DEMAND

Kit 4 tappi per cerniera

Set of 4 caps

1.4 ACCESSORI PER TAVOLINI - ACCESSORIES FOR TABLES

Gancio girevole - Rotable hook

	MATERIAL	PA
	COLOR	BLACK/GREY
	WEIGHT	0,011 kg



6045955

ON DEMAND

Gancio girevole per fissaggio tavolino
Rotable hook for table fixing



6045950



ON DEMAND

Gancio girevole per fissaggio tavolino
Rotable hook for table fixing

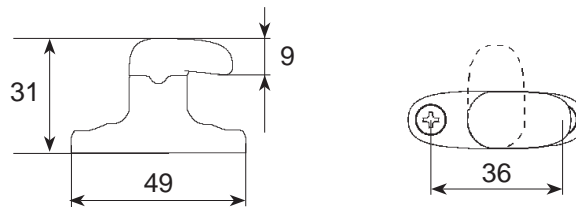
DIMENSIONI - DIMENSIONS



Distanziali - Spacer

	MATERIAL	PP
	COLOR	BLACK/GREY
	WEIGHT	0,03 kg



604645B

ON DEMAND

Kit composto da due distanziali di regolazione, destro e sinistro per sedili a sezione curva

Right and left hand spacer kit, for seats with rounded seatback



604645M

ON DEMAND



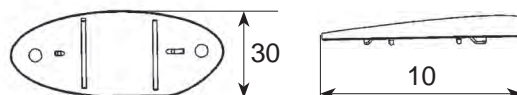

Kit composto da due distanziali di regolazione, destro e sinistro per sedili a sezione curva

Right and left hand spacer kit, for seats with rounded seatback

DIMENSIONI - DIMENSIONS



Tavolino A - Table A

	MATERIAL	PP
	COLOR	BLACK ●
	WEIGHT	0,404 kg
	COLLAPSE	7 kg



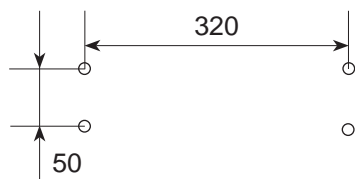
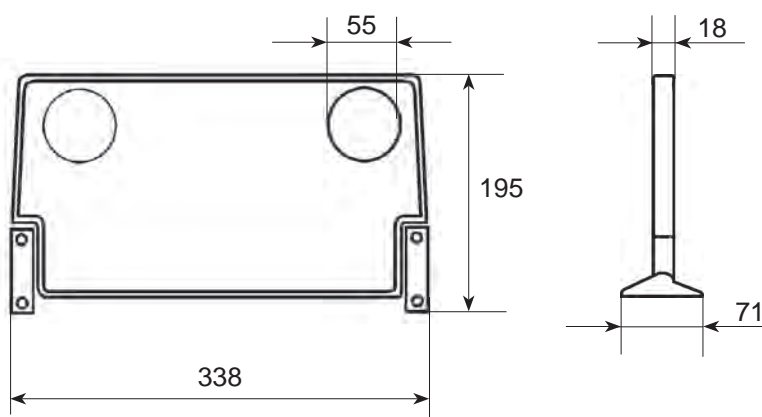
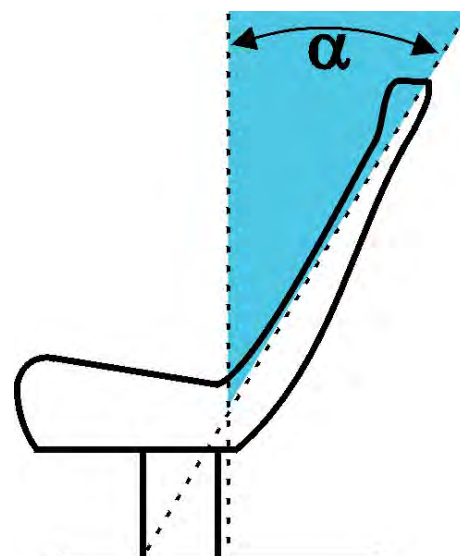

**6040995****ON DEMAND**

Tavolino A, inclinazione 15°
apertura verso il basso
completo di cerniere

Table A, inclination 15°
Downwards opening
complete with hinges

HOMOLOGATION R118**DIMA DI FORATURA
DRILL TEMPLATE****DIMENSIONI - DIMENSIONS****Tavolini con inclinazione variabile - Tables with variable inclination****6041325**Tavolino A, inclinazione $\alpha = 20^\circ$ Table A, inclination $\alpha = 20^\circ$ **6040985**Tavolino A, inclinazione $\alpha = 30^\circ$ Table A, inclination $\alpha = 30^\circ$ **6041085**Tavolino A, inclinazione $\alpha = 40^\circ$ Table A, inclination $\alpha = 40^\circ$ **6040205**Tavolino A, inclinazione $\alpha = 0^\circ$ Table A, inclination $\alpha = 0^\circ$ **6041185**Tavolino A, inclinazione $\alpha = 25^\circ$ Table A, inclination $\alpha = 25^\circ$ **6041415**Tavolino A, inclinazione $\alpha = 35^\circ$ Table A, inclination $\alpha = 35^\circ$ **6041435**Tavolino A, inclinazione $\alpha = 50^\circ$ Table A, inclination $\alpha = 50^\circ$ **6040995-HR**Tavolino A, inclinazione $\alpha = 15^\circ$ Table A, inclination $\alpha = 15^\circ$ **FIRE PROOF MATERIAL EN 45545-2
ON DEMAND****FIRE PROOF MATERIAL EN 45545-2**

Tavolino A1 - Table A1

	MATERIAL	PP
	COLOR	BLACK ●
	WEIGHT	0,426 kg
	COLLAPSE	7 kg





**604723B****ON DEMAND**

Tavolino A1, inclinazione 45°
apertura verso l'alto
completo di cerniere

Table A1, inclination 45°
Upwards opening
complete with hinges

HOMOLOGATION R118**FIRE PROOF MATERIAL EN 45545-2
ON DEMAND**

Tavolino A1 - Table A1

	MATERIAL	PP
	COLOR	GREY ●
	WEIGHT	0,426 kg
	COLLAPSE	7 kg





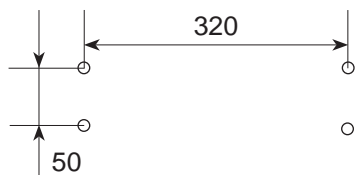
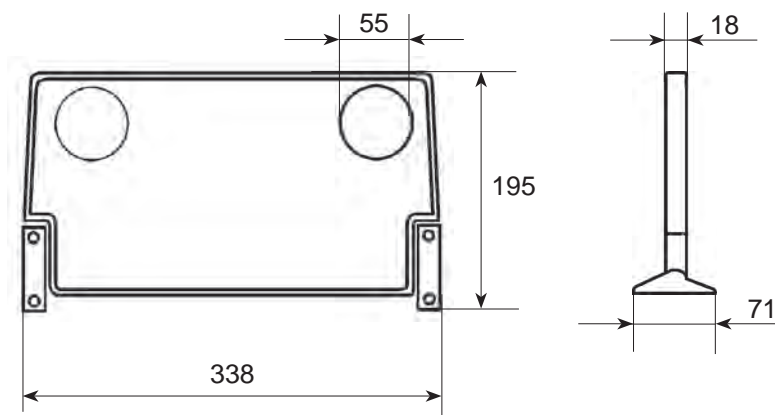

**604723M****ON DEMAND**

Tavolino A1, inclinazione 45°
apertura verso l'alto
completo di cerniere

Table A1, inclination 45°
Upwards opening
complete with hinges

**DIMA DI FORATURA
DRILL TEMPLATE****DIMENSIONI - DIMENSIONS**

Tavolino B1 - Table B1

	MATERIAL	PP
	COLOR	BLACK ●
	MIN. ORDER	105 pcs
	UNIT	35 pcs
	WEIGHT	0,415 kg
	COLLAPSE	6 kg

**6043525**

Tavolino B1, inclinazione 15°
apertura verso l'alto
completo di cerniere

Table B1, inclination 15°
Upwards opening
complete with hinges

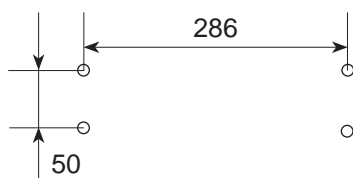
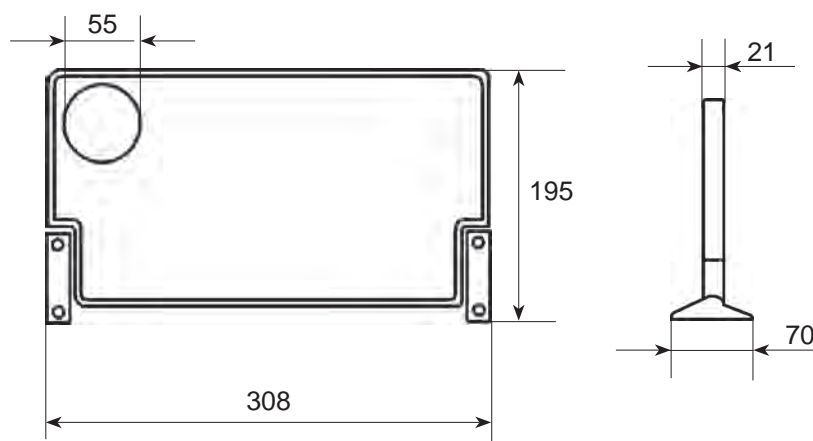
HOMOLOGATION R118**DIMA DI FORATURA
DRILL TEMPLATE****DIMENSIONI - DIMENSIONS****Tavolini con inclinazione variabile - Tables with variable inclination****6043535**

Tavolino B1, inclinazione $\alpha = 20^\circ$
Table B1, inclination $\alpha = 20^\circ$

6043555

Tavolino B1, inclinazione $\alpha = 30^\circ$
Table B1, inclination $\alpha = 30^\circ$

6043575

Tavolino B1, inclinazione $\alpha = 40^\circ$
Table B1, inclination $\alpha = 40^\circ$

6043595

Tavolino B1, inclinazione $\alpha = 0^\circ$
Table B1, inclination $\alpha = 0^\circ$

6043545

Tavolino B1, inclinazione $\alpha = 25^\circ$
Table B1, inclination $\alpha = 25^\circ$

6043565

Tavolino B1, inclinazione $\alpha = 35^\circ$
Table B1, inclination $\alpha = 35^\circ$

6043585





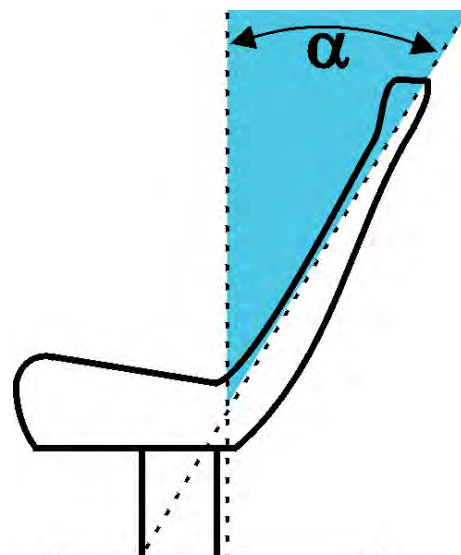

Tavolino B1, inclinazione $\alpha = 50^\circ$
Table B1, inclination $\alpha = 50^\circ$

6043415

Tavolino B1, inclinazione $\alpha = 10^\circ$
Table B1, inclination $\alpha = 10^\circ$

ON DEMAND**FIRE PROOF MATERIAL EN 45545-2
ON DEMAND**

Tavolino B2 - Table B2

	MATERIAL	PP
	COLOR	BLACK ●
	MIN. ORDER	100 pcs
	UNIT	25 pcs
	WEIGHT	0,415 kg
	COLLAPSE	6 kg



6043425

ON DEMAND

Tavolino B2, inclinazione 15°
apertura verso il basso
completo di cerniere

Table B2, inclination 15°
Downwards opening
complete with hinges

HOMOLOGATION R118

DIMA DI FORATURA DRILL TEMPLATE



DIMENSIONI - DIMENSIONS

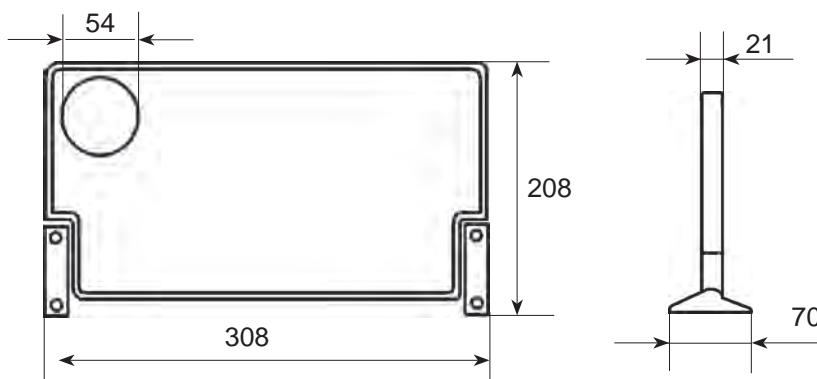

Tavolini con inclinazione variabile - Tables with variable inclination

6043435

ON DEMAND

Tavolino B2, inclinazione $\alpha = 20^\circ$
Table B2, inclination $\alpha = 20^\circ$

6043455

ON DEMAND

Tavolino B2, inclinazione $\alpha = 30^\circ$
Table B2, inclination $\alpha = 30^\circ$

6043475

ON DEMAND

Tavolino B2, inclinazione $\alpha = 40^\circ$
Table B2, inclination $\alpha = 40^\circ$

6043435-HR **ON DEMAND**

Tavolino B2, inclinazione $\alpha = 20^\circ$
Table B2, inclination $\alpha = 20^\circ$

6043425-HR **ON DEMAND**

Tavolino B2, inclinazione $\alpha = 15^\circ$
Table B2, inclination $\alpha = 15^\circ$

FIRE PROOF MATERIAL EN 45545-2

6043445

ON DEMAND

Tavolino B2, inclinazione $\alpha = 25^\circ$
Table B2, inclination $\alpha = 25^\circ$

6043465

ON DEMAND

Tavolino B2, inclinazione $\alpha = 35^\circ$
Table B2, inclination $\alpha = 35^\circ$

6043485

ON DEMAND

Tavolino B2, inclinazione $\alpha = 50^\circ$
Table B2, inclination $\alpha = 50^\circ$

6043495

ON DEMAND

Tavolino B2, inclinazione $\alpha = 0^\circ$
Table B2, inclination $\alpha = 0^\circ$

**FIRE PROOF MATERIAL EN 45545-2
ON DEMAND**

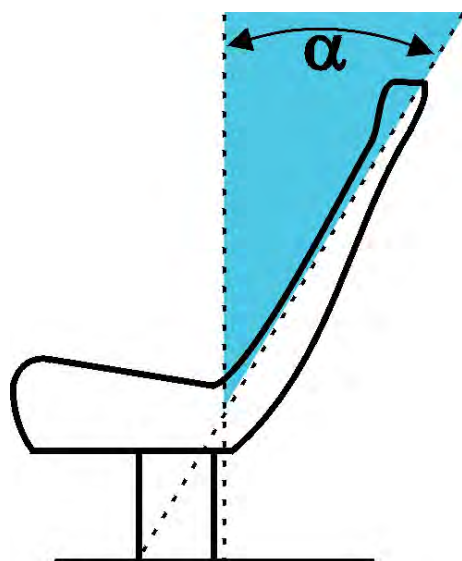

Distanziali - Spacer



MATERIAL ABS



COLOR BLACK/GREY



WEIGHT 0,005 kg

**6045730****ON DEMAND**

Distanziale di regolazione destro, per sedili a sezione curva, adatto ai mod. A-A1-B1-B2

Right spacer, for seats with rounded seat-back, for model A-A1-B1-B2

**6045720****ON DEMAND**

Distanziale di regolazione sinistro, per sedili a sezione curva, adatto ai mod. A-A1-B1-B2

Left spacer, for seats with rounded seat-back, for type A-A1-B1-B2

**6045737****ON DEMAND**

Distanziale di regolazione destro, per sedili a sezione curva, adatto ai mod. A-A1-B1-B2

Right spacer, for seats with rounded seat-back, for type A-A1-B1-B2

**6045727****ON DEMAND**



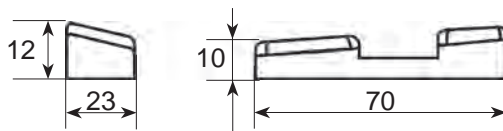

Distanziale di regolazione sinistro, per sedili a sezione curva, adatto ai mod. A-A1-B1-B2

Left spacer, for seats with rounded seat-back, for type A-A1-B1-B2

DIMENSIONI - DIMENSIONS



Portagiornali a rete 6x5 maglie - Magazine nets 6x5 meshes





	MATERIAL	PP-PA
	COLOR	BLACK ●
	MIN. ORDER	220 pcs
	UNIT	110 pcs
	WEIGHT	0,083 kg



HOMOLOGATION R118

6064785

Portagiornali a rete 6x5 maglie
Magazine net, 6x5 meshes



	MATERIAL	PP-PA
	COLOR	GREY ●
	MIN. ORDER	220 pcs
	UNIT	110 pcs
	WEIGHT	0,083 kg



HOMOLOGATION R118

6064780

Portagiornali a rete 6x5 maglie
Magazine net, 6x5 meshes

	MATERIAL	PP V0
	COLOR	BLACK ●
	WEIGHT	0,083 kg



FIRE PROOF MATERIAL EN 45545-2

6064785-HR **ON DEMAND**

Portagiornali a rete 6x5 maglie
Materiale autoestinguente
Magazine net, 6x5 meshes
Self-extinguishing material

DIMA DI FORATURA DRILL TEMPLATE

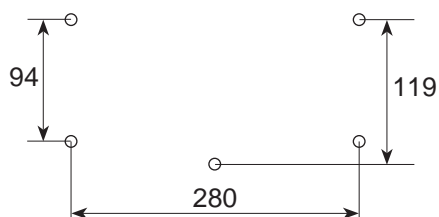

DIMENSIONI - DIMENSIONS

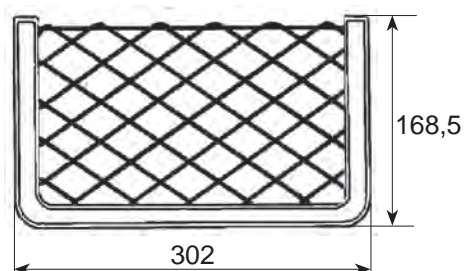

1.5

PORTAGIORNALI A RETE - MAGAZINE NETS

Portagiornali a rete 7x5 maglie - Magazine nets 7x5 meshes



MATERIAL PP - ABS



COLOR BLACK ●



MIN. ORDER 200 pcs



UNIT 100 pcs



WEIGHT 0,091 kg



HOMOLOGATION R118

6064885

Portagiornali a rete 7x5 maglie

Magazine net, 7x5 meshes



MATERIAL PP - ABS



COLOR GREY ●



MIN. ORDER 200 pcs



UNIT 100 pcs



WEIGHT 0,091 kg

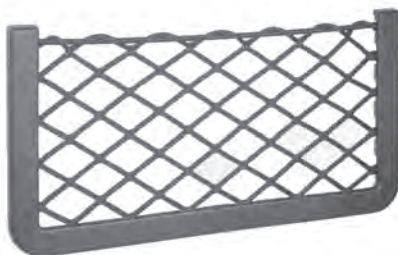

HOMOLOGATION R118

606488M

Portagiornali a rete 7x5 maglie

Magazine net, 7x5 meshes

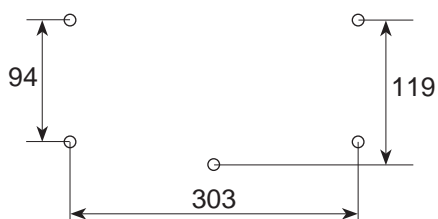

DIMA DI FORATURA DRILL TEMPLATE

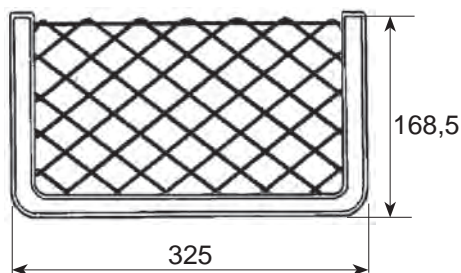

DIMENSIONI - DIMENSIONS



Portagiornali a rete 7x5 maglie - Magazine nets 7x5 meshes

	MATERIAL	PP-ABS
	COLOR	BLACK ●
	WEIGHT	0,091 kg





6064885-ST ON DEMAND

Portagiornali a rete 7x5 maglie, con viti, senza tappi

Magazine nets, 7x5 meshes, with screws, without caps

HOMOLOGATION R118

	MATERIAL	PP V0
	COLOR	BLACK ●
	WEIGHT	0,091 kg



6064885-HR ON DEMAND

Portagiornali a rete 7x5 maglie, con viti, senza tappi. Materiale autoestingente

Magazine nets, 7x5 meshes, with screws, without caps. Self-extinguishing material

FIRE PROOF MATERIAL EN 45545-2

DIMA DI FORATURA DRILL TEMPLATE

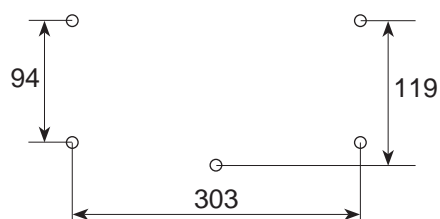

DIMENSIONI - DIMENSIONS

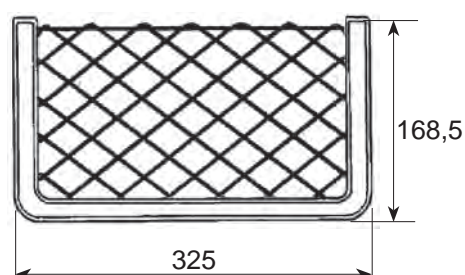

Portagiornali a rete 8x4 maglie - Magazine nets 8x4 meshes



MATERIAL PP-PA



COLOR BLACK ●



MIN. ORDER 200 pcs



UNIT 200 pcs



WEIGHT 0,090 kg



6064685

Portagiornali a rete 8x4 maglie

Magazine net, 8x4 meshes

HOMOLOGATION R118



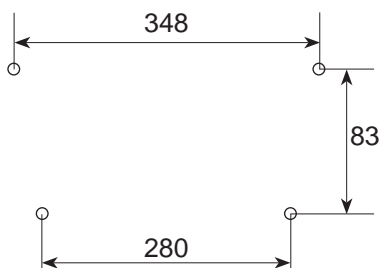

DIMA DI FORATURA DRILL TEMPLATE

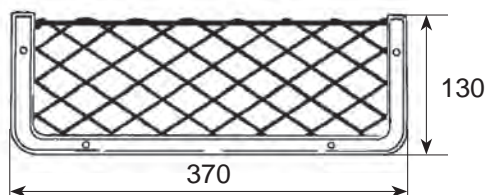

DIMENSIONI - DIMENSIONS



Portagiornali a rete 8x5 maglie - Magazine nets 8x5 meshes





	MATERIAL	PC-ABS
	COLOR	BLACK ●
	MIN. ORDER	240 pcs
	UNIT	80 pcs
	WEIGHT	0,092 kg



6065015

Portagiornali a rete 8x5 maglie
Magazine net, 8x5 meshes

R118 ON DEMAND

	MATERIAL	PC-ABS
	COLOR	GREY ●
	MIN. ORDER	240 pcs
	UNIT	80 pcs
	WEIGHT	0,092 kg



6065011

Portagiornali a rete 8x5 maglie
Magazine net, 8x5 meshes

R118 ON DEMAND

DIMA DI FORATURA DRILL TEMPLATE

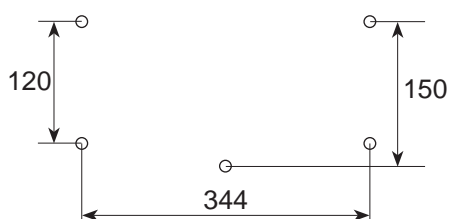

DIMENSIONI - DIMENSIONS

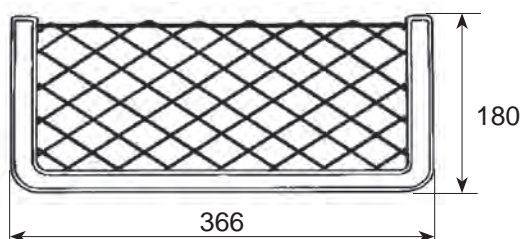

Portagiornali a rete 8x5 maglie - Magazine nets 8x5 meshes



MATERIAL PC-ABS



COLOR BLACK ●



MIN. ORDER 240 pcs



UNIT 80 pcs



WEIGHT 0,093 kg



HOMOLOGATION R118

6065175

Portagiornali a rete 8x5 maglie, con viti, senza tappi

Magazine nets, 8x5 meshes, with screws, without caps



MATERIAL PP V0



COLOR BLACK ●



WEIGHT 0,093 kg



FIRE PROOF MATERIAL EN 45545-2

6065175-HR

Portagiornali a rete 8x5 maglie, con viti, senza tappi. Materiale autoestinguente

Magazine nets, 8x5 meshes, with screws, without caps. Self-extinguishing material



MATERIAL PC-ABS



COLOR GREY ●



MIN. ORDER 240 pcs



UNIT 80 pcs



WEIGHT 0,093kg



HOMOLOGATION R118

6065171

Portagiornali a rete 8x5 maglie, con viti, senza tappi

Magazine nets, 8x5 meshes, with screws, without caps



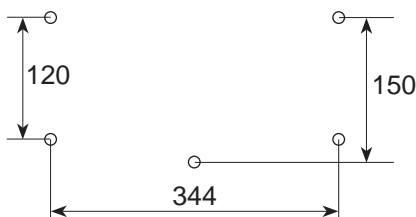

DIMA DI FORATURA DRILL TEMPLATE

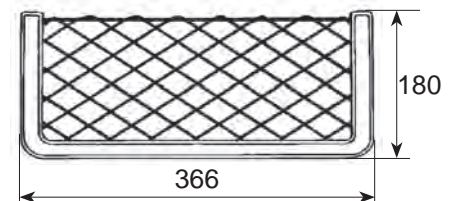

DIMENSIONI - DIMENSIONS



Portagiornali a rete 9x5 maglie - Magazine nets 9x5 meshes



	MATERIAL	PP-PA
	COLOR	BLACK ●
	MIN. ORDER	150 pcs
	UNIT	150 pcs
	WEIGHT	0,100 kg



6064795

Portagiornali a rete 9x5 maglie
Magazine net, 9x5 meshes

HOMOLOGATION R118





	MATERIAL	PP VO
	COLOR	BLACK ●
	WEIGHT	0,100 kg



6064795-HR

Portagiornali a rete 9x5 maglie
Materiale autoestinguente
Magazine net, 9x5 meshes
Self-extinguishing material

FIRE PROOF MATERIAL EN 45545-2

	MATERIAL	PP-PA
	COLOR	GREY ●
	MIN. ORDER	150 pcs
	UNIT	150 pcs
	WEIGHT	0,100 kg



6064790

Portagiornali a rete 9x5 maglie
Magazine net, 9x5 meshes

HOMOLOGATION R118

DIMA DI FORATURA DRILL TEMPLATE

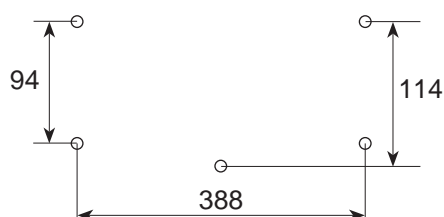

DIMENSIONI - DIMENSIONS

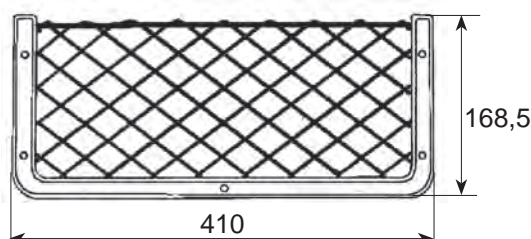

Portagiornali a rete 9x6maglie - Magazine nets 9X6 meshes



MATERIAL PP-PA



COLOR BLACK ●



MIN. ORDER 260 pcs



UNIT 130 pcs



WEIGHT 0,120 kg



6064695

Portagiornali a rete 9X6 maglie

Magazine net, 9X6 meshes

HOMOLOGATION R118



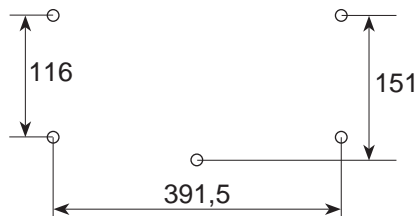

DIMA DI FORATURA DRILL TEMPLATE

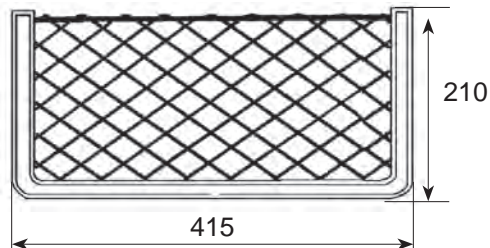

DIMENSIONI - DIMENSIONS



Portagiornali a 5 elementi - Backseat organizer 5 elements

	MATERIAL	PP-ABS
	COLOR	BLACK ●
	MIN. ORDER	240 pcs
	UNIT	80 pcs
	WEIGHT	0,110 kg





HOMOLOGATION R118

6061755

Portagiornali a 5 elementi

Backseat organizer with 5 elements

	MATERIAL	PP-ABS
	COLOR	BLACK ●
	WEIGHT	0,110 kg





HOMOLOGATION R118

6062755

ON DEMAND

Portagiornali a 5 elementi a base fissa

Backseat organizer with 5 elements stiff base

	MATERIAL	PP-ABS
	COLOR	GREY ●
	WEIGHT	0,110 kg



HOMOLOGATION R118

606175M

ON DEMAND

Portagiornali a 5 elementi

Backseat organizer with 5 elements

DIMA DI FORATURA DRILL TEMPLATE

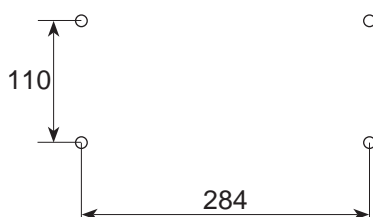

DIMENSIONI - DIMENSIONS

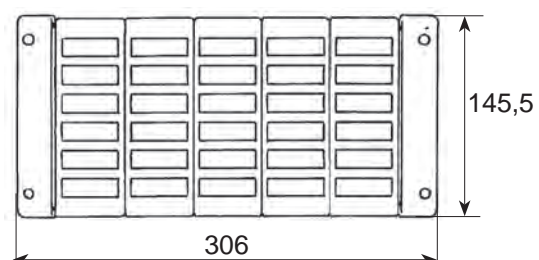

1.5

PORTAGIORNALI - BACKSEAT ORGANIZERS

Portagiornali a 6 elementi - Backseat organizer 6 elements



MATERIAL PP-ABS



COLOR BLACK ●



MIN. ORDER 210 pcs



UNIT 70 pcs



WEIGHT 0,120 kg



6061765

Portagiornali a 6 elementi

Backseat organizer with 6 element

HOMOLOGATION R118



MATERIAL PP V0



COLOR BLACK ●



MIN. ORDER 210 pcs



UNIT 70 pcs



WEIGHT 0,110 kg



606531B

Portagiornali a 6 elementi a base fissa,
materiale autoestinguente per treni

Backseat organizer with 6 elements,
stiff base, self-extinguishing material for
trains

FIRE PROOF MATERIAL EN 45545-2

DIMA DI FORATURA DRILL TEMPLATE



DIMENSIONI - DIMENSIONS

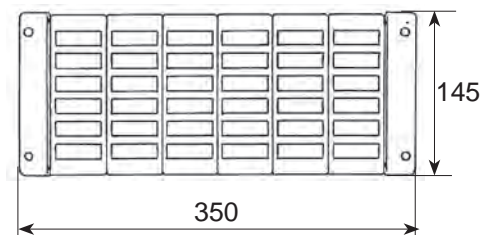

Portagiornali a 6 elementi - Backseat organizer 6 elements



MATERIAL PP-ABS



COLOR BLACK ●



WEIGHT 0,187 kg



6062765

ON DEMAND

Portagiornali a 6 elementi a base fissa
Backseat organizer with 6 elements stiff base

HOMOLOGATION R118



MATERIAL PP-ABS



COLOR GREY ●



WEIGHT 0,120 kg



606176M

ON DEMAND

Portagiornali a 6 elementi
Backseat organizer with 6 elements

HOMOLOGATION R118

DIMA DI FORATURA DRILL TEMPLATE

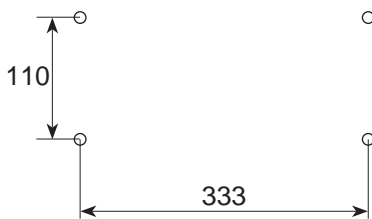

DIMENSIONI - DIMENSIONS

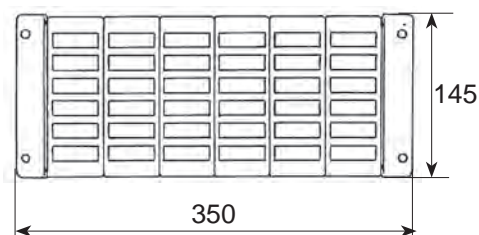

1.5

PORTAGIORNALI - BACKSEAT ORGANIZERS

Portagiornali a 7 elementi - Backseat organizer 7 elements



MATERIAL PP-ABS



COLOR BLACK ●



MIN. ORDER 220 pcs



UNIT 55 pcs



WEIGHT 0,136 kg



6061775

Portagiornali a 7 elementi

Backseat organizer with 7 elements

HOMOLOGATION R118



MATERIAL PP-ABS



COLOR BLACK ●



WEIGHT 0,210 kg



6062775

ON DEMAND

Portagiornali a 7 elementi a base fissa

Backseat organizer with 7 elements stiff base

HOMOLOGATION R118



MATERIAL PP-ABS



COLOR GREY ●



WEIGHT 0,136 kg



606177M

ON DEMAND

Portagiornali a 7 elementi

Backseat organizer with 7 elements

HOMOLOGATION R118

DIMA DI FORATURA DRILL TEMPLATE

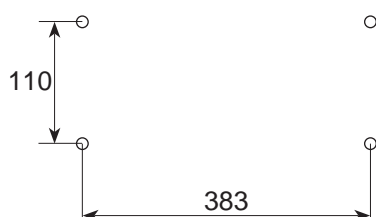

DIMENSIONI - DIMENSIONS

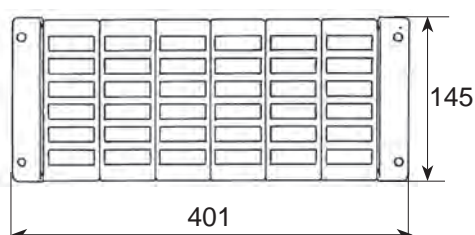

Tasca portaoggetti - Multi purpose container



MATERIAL PP



COLOR GREY ●



WEIGHT 0,081 kg



801534K

ON DEMAND

Tasca portaoggetti

Multi purpose container

HOMOLOGATION R118

DIMA DI FORATURA DRILL TEMPLATE

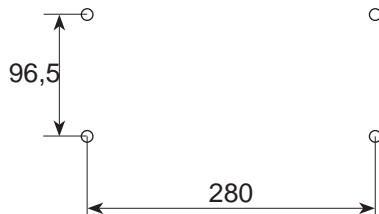

DIMENSIONI - DIMENSIONS

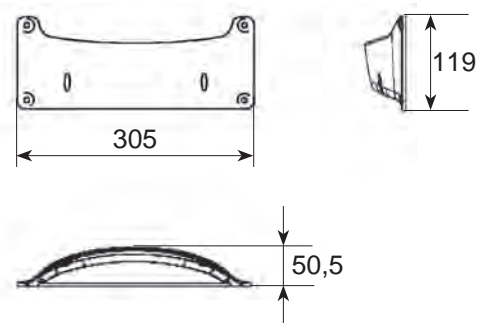

Portabicchiere Leonardo 2

6052535

Portabicchiere "Leonardo 2" per bicchieri, lattine e contenitori rettangolari

"Leonardo 2" cupholder suitable for cups and tins as well as bottles and square paper packs

A richiesta anche con tenuta maggiore

Provided with higher load on demand



HOMOLOGATION R118

	MATERIAL	PP-PA
	COLOR	BLACK ●
	MIN. ORDER	180 pcs
	UNIT	90 pcs
	WEIGHT	0,128 kg

DIMENSIONI - DIMENSIONS

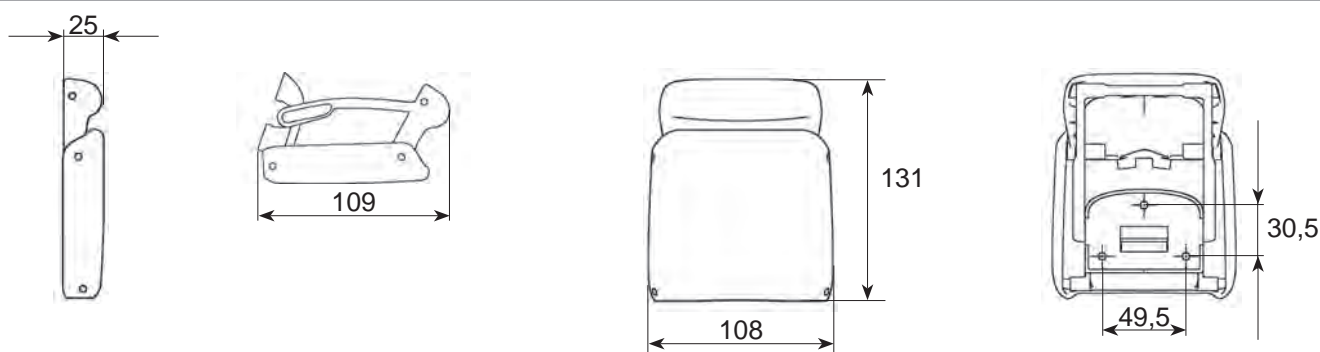

Portabicchiere Leonardo

6052335

ON DEMAND

Portabicchiere "Leonardo" per bicchieri, lattine e contenitori rettangolari

"Leonardo" cupholder suitable for cups and tins as well as bottles and square paper packs





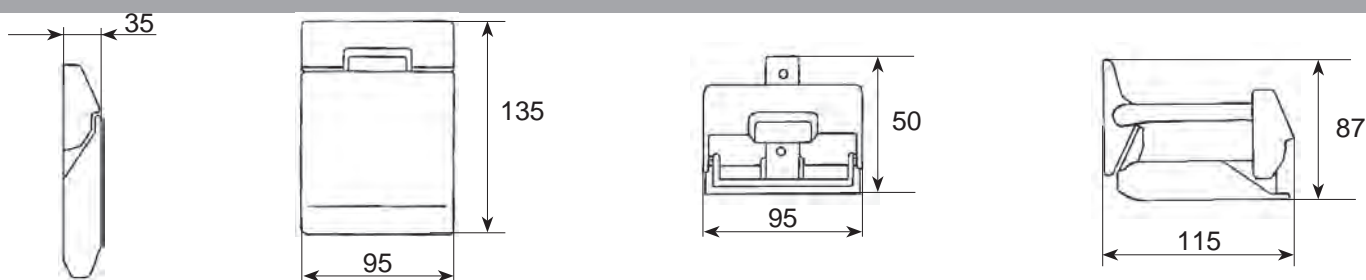

HOMOLOGATION R118

	MATERIAL	PA
	COLOR	BLACK ●
	WEIGHT	0,100 kg

DIMENSIONI - DIMENSIONS



Portabicchiere ad anello - Ring cupholders

	MATERIAL	PA
	COLOR	BLACK ●
	MIN. ORDER	320 pcs
	UNIT	80 pcs
	WEIGHT	0,067 kg







HOMOLOGATION R118

6052295

Portabicchiere ad anello per bicchieri e lattine, gancio corto

Ring cupholder for cups and tins, short hook

	MATERIAL	PA
	COLOR	GREY ●
	MIN. ORDER	320 pcs
	UNIT	80 pcs
	WEIGHT	0,067 kg



HOMOLOGATION R118

6052290



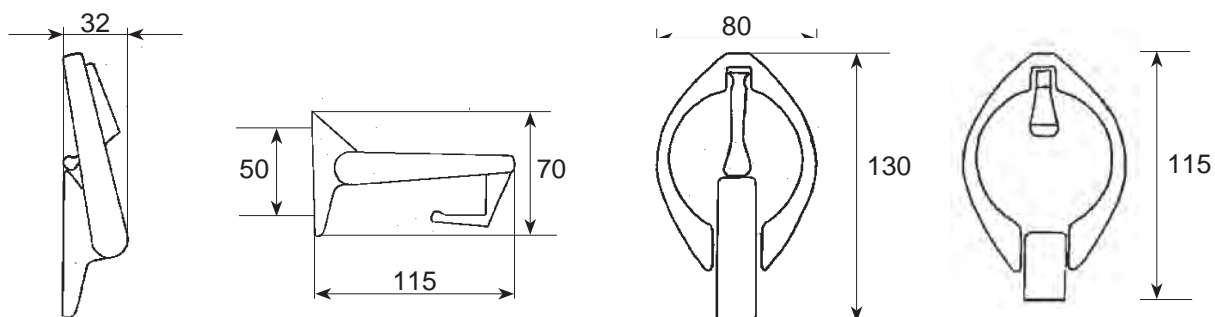

Portabicchiere ad anello per bicchieri e lattine, gancio corto

Ring cupholder for cups and tins, short hook

DIMENSIONI - DIMENSIONS



Portabicchiere ad anello - Ring cupholder

	MATERIAL	PA
	COLOR	BLACK ●
	MIN. ORDER	320 pcs
	UNIT	80 pcs
	WEIGHT	0,070 kg







HOMOLOGATION R118

8005525

Portabicchiere ad anello per bicchieri, lattine e bottigliette, gancio lungo

Ring cupholder for cups, tins and bottles, long hook

	MATERIAL	PA - V0
	COLOR	BLACK ●
	MIN. ORDER	320 pcs
	UNIT	80 pcs
	WEIGHT	0,070 kg



HOMOLOGATION R118

8005525 -HR

Portabicchiere ad anello per bicchieri, lattine e bottigliette, gancio lungo



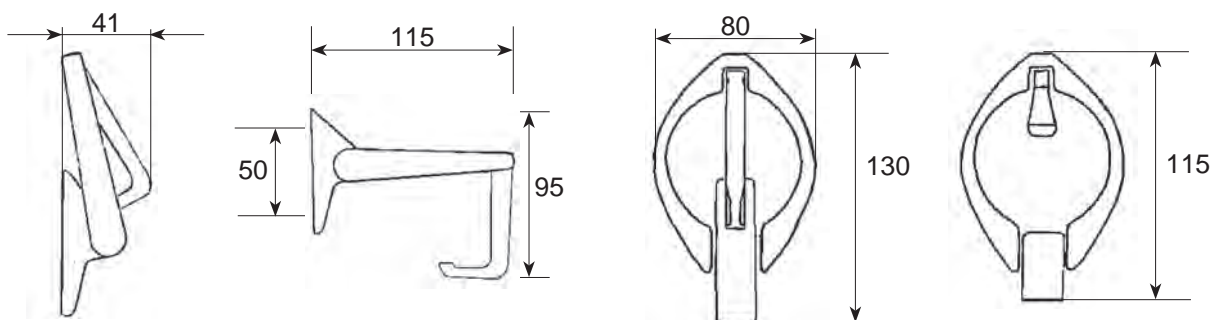

Ring cupholder for cups, tins and bottles, long hook

EN 45545 ON DEMAND

DIMENSIONI - DIMENSIONS



Portarifiuti destro - Right dustbin

	MATERIAL	PC-ABS-PA
	COLOR	BLACK ●
	WEIGHT	0,414 kg
	CAPACITY	2 L



801529B





ON DEMAND

Contenitore per rifiuti destro ruotabile e asportabile per pulizia

Right hand dustbin, removable for emptying and cleaning

HOMOLOGATION R118

Portarifiuti sinistro - Left dustbin

	MATERIAL	PC-ABS-PA
	COLOR	BLACK ●
	WEIGHT	0,414 kg
	CAPACITY	2 L



801530B

ON DEMAND

Contenitore per rifiuti sinistro ruotabile e asportabile per pulizia

Left hand dustbin, removable for emptying and cleaning

HOMOLOGATION R118

DIMENSIONI - DIMENSIONS

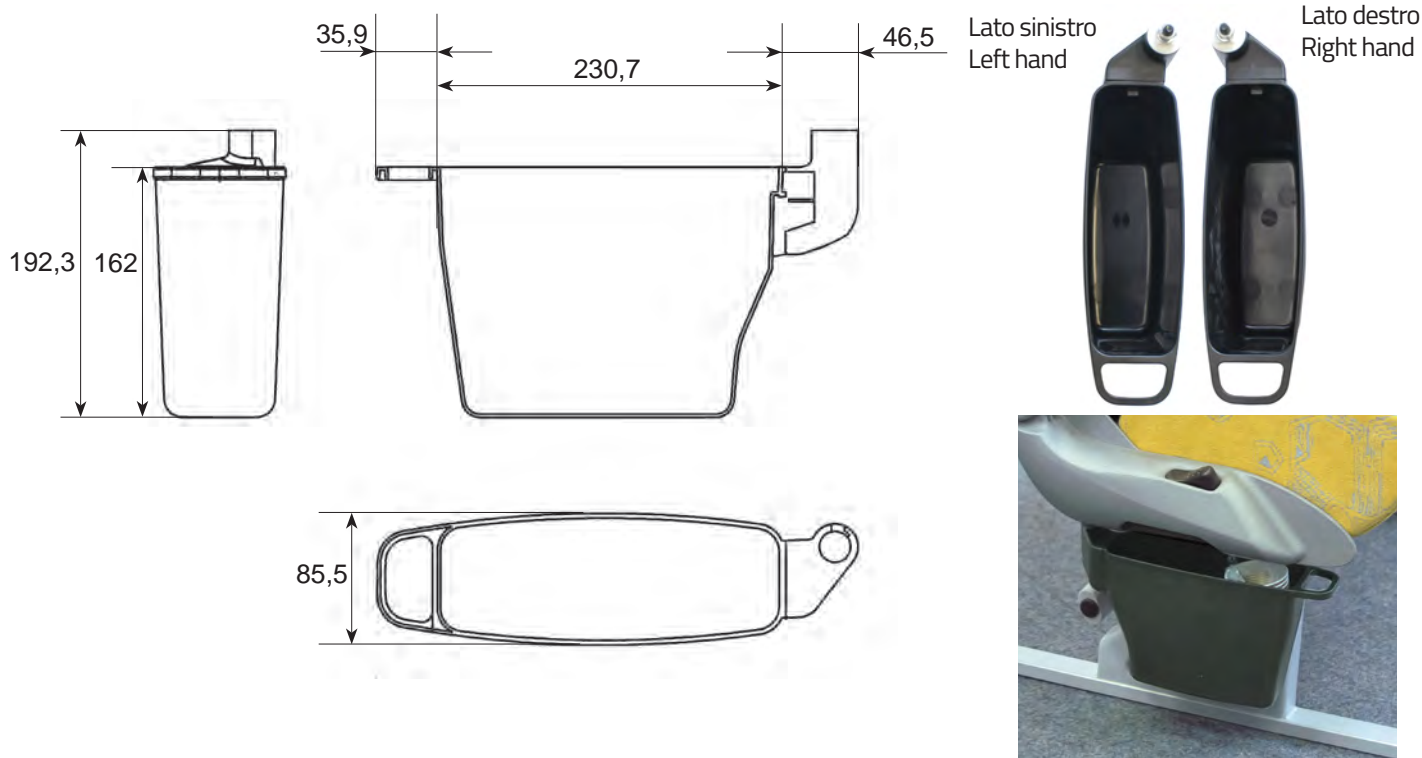

Appoggiapiedi T3 - T3 footrest

6085500

Appoggiapiedi con ritorno a 3 scatti e fissaggio orizzontale

Footrest with return to the rest position in 3 steps, horizontal fixing



HOMOLOGATION R118

	MATERIAL	PP-PA-AL
	COLOR	GREY ●
	MIN. ORDER	105 pcs
	UNIT	35 pcs
	WEIGHT	0,981 kg
	BREAKING	200 kg

DIMENSIONI - DIMENSIONS

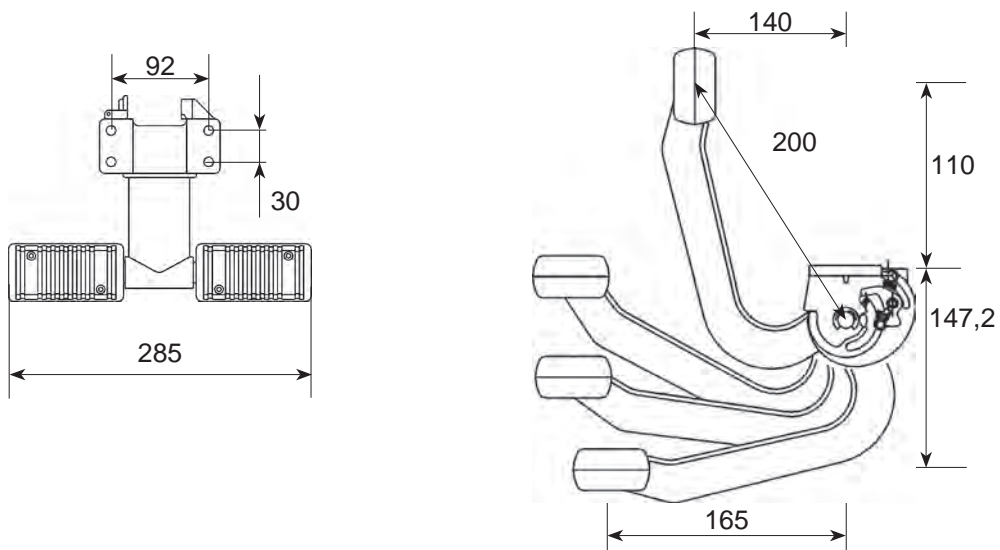

Accessori per appoggiapiedi T3 - Accessories for T3 footrest

608692M

Coperture laterali, per modelli: T, T3, V, BC, BC-VO, BC3

Side covers for model: T, T3, V, BC, BC-VO, BC3



HOMOLOGATION R118

	MATERIAL	PA
	COLOR	GREY ●
	MIN. ORDER	90 pcs
	UNIT	45 pcs
	WEIGHT	0,09 kg

Appoggiapiedi VH - VH footrest



MATERIAL PA-ABS-AL



COLOR GREY ●



MIN. ORDER 105 pcs



UNIT 35 pcs



WEIGHT 0,940 kg



BREAKING 200 kg

**608698N**Appoggiapiedi con ritorno a 4 scatti,
fissaggio orizzontaleFootrest with return to the rest
position in 4 steps, horizontal fixing

HOMOLOGATION R118

DIMENSIONI - DIMENSIONS

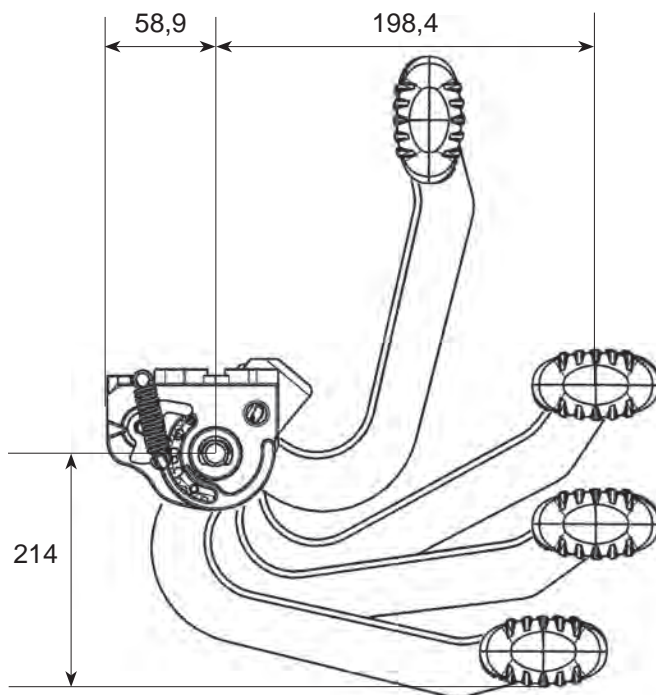
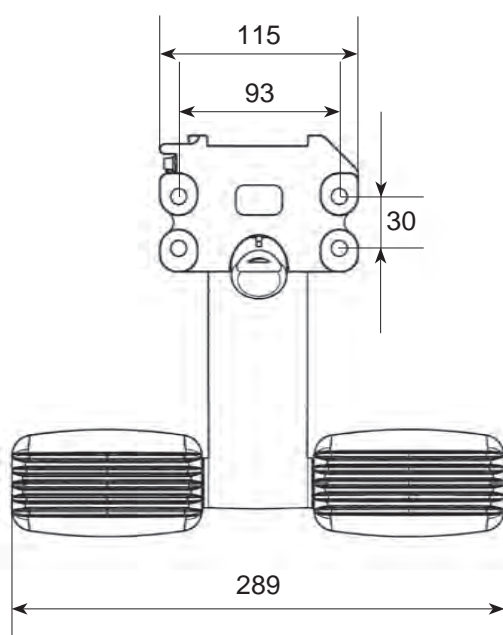

Appoggiapiedi T3-V0 - T3-V0 footrest

6085501-V0

Appoggiapiedi a 4 posizioni aperto
chiuso fissaggio orizzontale

Footrest 4 positions, open - close
horizontal fixing







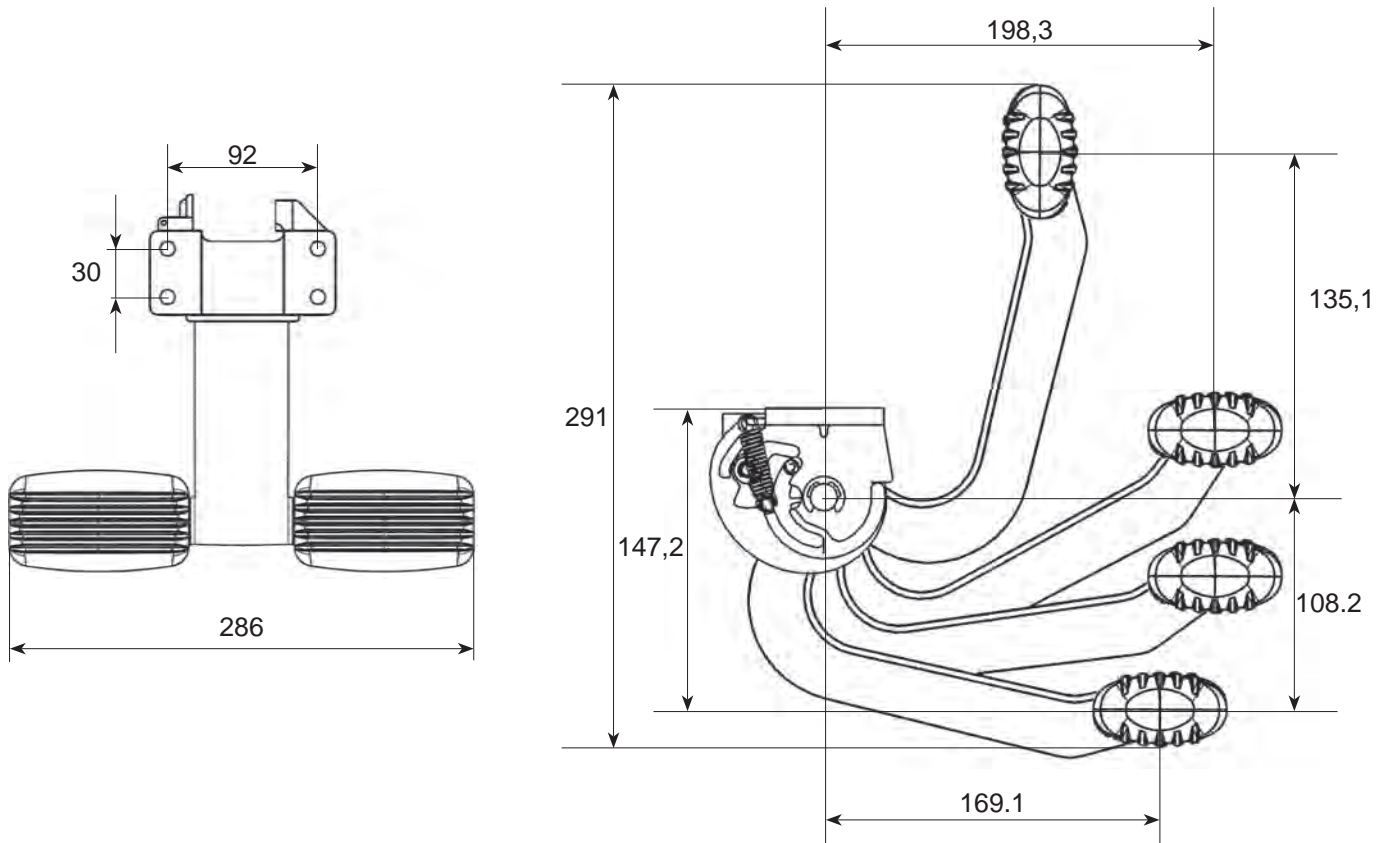

FIRE PROOF MATERIAL EN 45545-2

	MATERIAL	PA V0-AL
	COLOR	GREY ●
	MIN. ORDER	105 pcs
	UNIT	35 pcs
	WEIGHT	0,940 kg
	BREAKING	200 kg

DIMENSIONI - DIMENSIONS



Appoggiapiedi BC-VO - BC-VO footrest

	MATERIAL	PA VO-AL
	COLOR	GREY ●
	MIN. ORDER	90 pcs
	UNIT	30 pcs
	WEIGHT	1,046 kg
	BREAKING	200 kg

FIRE PROOF MATERIAL EN 45545-2

**608689C**

Appoggiapiedi con ritorno a 4 scatti, fissaggio orizzontale e braccio corto con coperture laterali

Footrest with return to the rest position in 4 steps, horizontal fixing, short arm, with side covers

608689M - HR (painted)



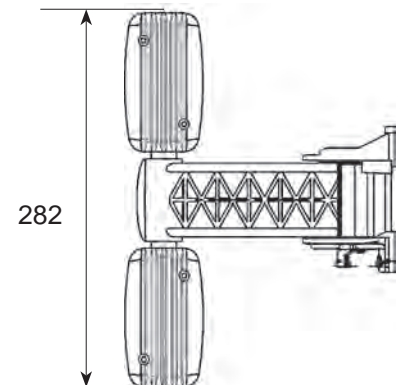
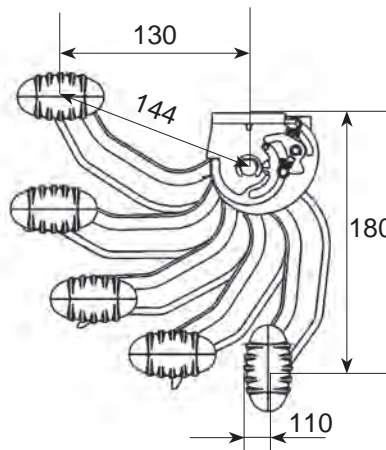
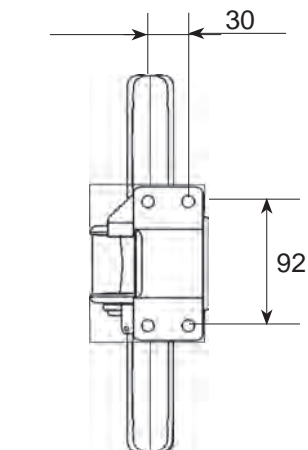

Appoggiapiedi con ritorno a 4 scatti, fissaggio orizzontale e braccio corto con coperture laterali

Footrest with return to the rest position in 4 steps, horizontal fixing, short arm, with side covers

DIMENSIONI - DIMENSIONS



Accessori inclusi per appoggiapiedi BC-VO - Accessories included for BC-VO footrest

	MATERIAL	PA
	COLOR	GREY ●
	MIN. ORDER	90 pcs
	UNIT	45 pcs
	WEIGHT	0,09 kg



HOMOLOGATION R118

608692M

Coperture laterali, per modelli: T, T3, V, BC, BC-VO, BC3

Side covers for model: T, T3, V, BC, BC-VO, BC3

Appoggiapiedi BC3 - BC3 footrest

6085560

Appoggiapiedi con ritorno a 3 scatti, fissaggio orizzontale e braccio corto

Footrest with return to the rest position in 3 steps, horizontal fixing, short arm



HOMOLOGATION R118

	MATERIAL	PA-PP-AL
	COLOR	GREY ●
	MIN. ORDER	90 pcs
	UNIT	45 pcs
	WEIGHT	0,860 kg
	BREAKING	200 kg

DIMENSIONI - DIMENSIONS

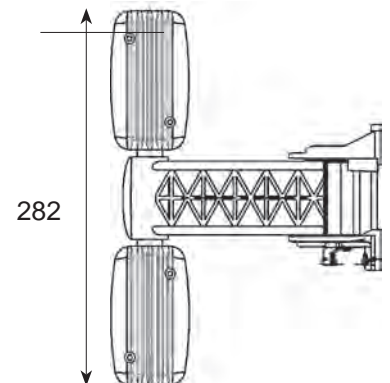
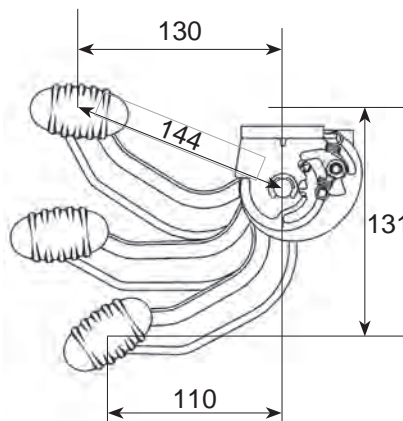
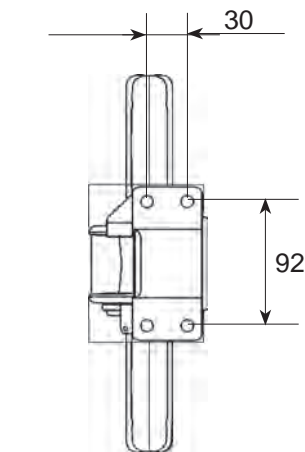

Accessori per appoggiapiedi BC3 - Accessories for BC3 footrest

608692M

Coperture laterali, per modelli: T, T3, V, BC, BC-VO, BC3







Side covers for model: T, T3, V, BC, BC-VO, BC3



HOMOLOGATION R118

	MATERIAL	PA
	COLOR	GREY ●
	MIN. ORDER	90 pcs
	UNIT	45 pcs
	WEIGHT	0,09 kg

Appoggiapiedi PL - PL footrest

	MATERIAL	PP-PA-AL
	COLOR	GREY ●
	MIN. ORDER	120 pcs
	UNIT	60 pcs
	WEIGHT	0,652 kg
	BREAKING	200 kg

**6085640**

Appoggiapiedi a 2 posizioni fissaggio sotto il sedile

Footrest with 2 positions, horizontal fixing

HOMOLOGATION R118

DIMENSIONI - DIMENSIONS

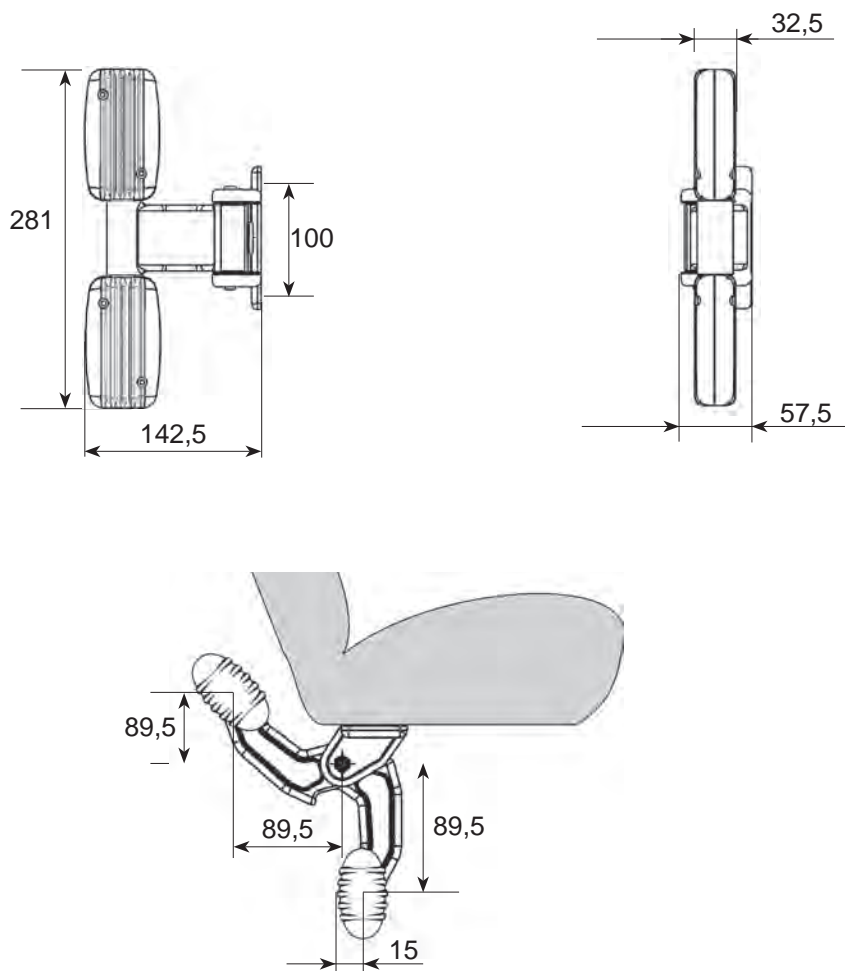

Appoggiapiedi PC - PC footrest

608645N







ON DEMAND

Appoggiapiedi con due posizioni

Footrest with two positions, wall fixing, short arm





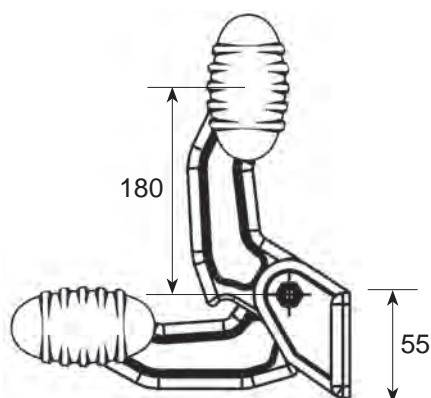
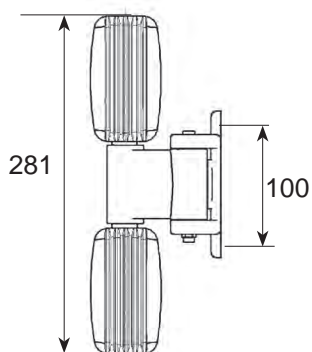

HOMOLOGATION R118

	MATERIAL	PA-ABS-AL
	COLOR	GREY ●
	MIN. ORDER	140 pcs
	UNIT	70 pcs
	WEIGHT	0,650 kg
	BREAKING	200 kg

DIMENSIONI - DIMENSIONS



Appoggiapiedi GIO' V0 - GIO' V0 footrest

	MATERIAL	PA V0-AL
	COLOR	GREY ●
	MIN. ORDER	100 pcs
	UNIT	50 pcs
	WEIGHT	0,502 kg
	BREAKING	200 kg

**608602N****ON DEMAND**

Appoggiapiedi a 2 posizioni aperto chiuso, fissaggio orizzontale.

Footrest 2 positions, open - close horizontal fixing.

FIRE PROOF MATERIAL EN 45545-2

DIMENSIONI - DIMENSIONS

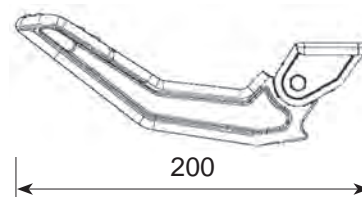
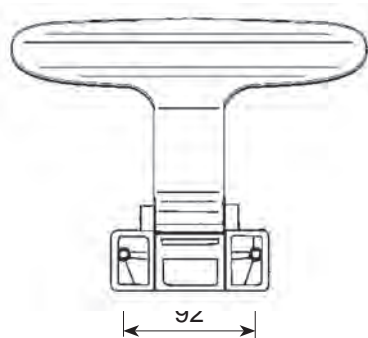
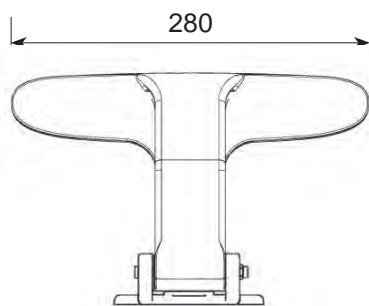

Appoggiapiedi GIO' - GIO' footrest

608693N





ON DEMAND

Appoggiapiedi a 2 posizioni aperto
chiuso fissaggio orizzontale

Footrest 2 positions, open - close
horizontal fixing





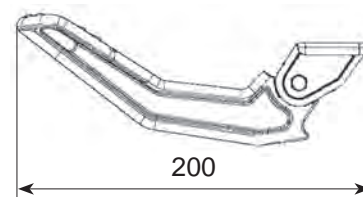
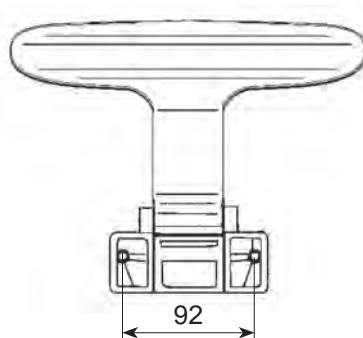
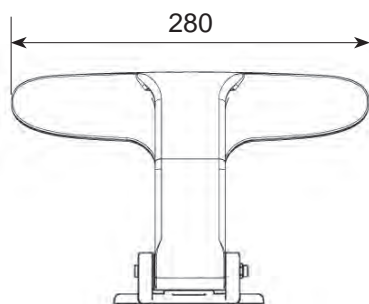

HOMOLOGATION R118

	MATERIAL	PA-AL
	COLOR	GREY ●
	WEIGHT	0,520 kg
	BREAKING	200 kg

DIMENSIONI - DIMENSIONS



Appoggiapiedi T - T footrest

	MATERIAL	PP-PA-AL
	COLOR	GREY ●
	WEIGHT	1,090 kg
	BREAKING	200 kg

**6085100****ON DEMAND**

Appoggiapiedi con ritorno a 4 scatti e fissaggio orizzontale



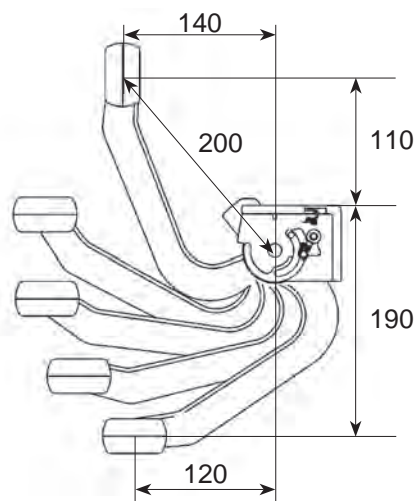
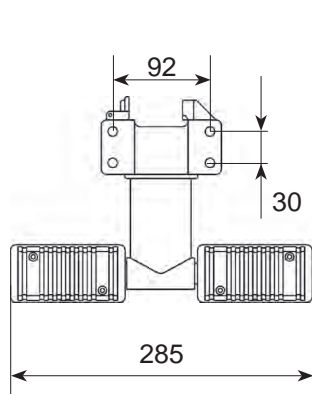

Footrest with return to the rest position in 4 steps, horizontal fixing

HOMOLOGATION R118

DIMENSIONI - DIMENSIONS



Accessori per appoggiapiedi T - Accessories for T footrest

	MATERIAL	PA
	COLOR	GREY ●
	MIN. ORDER	90 pcs
	UNIT	45 pcs
	WEIGHT	0,09 kg

**608692M**

Coperture laterali, per modelli: T, T3, V, BC, BC-VO, BC3

Side covers for model: T, T3, V, BC, BC-VO, BC3

HOMOLOGATION R118

Appoggiapiedi V - V footrest

6085527

ON DEMAND

Appoggiapiedi con ritorno a 4 scatti, fissaggio orizzontale e braccio corto, pedali in polipropilene

Footrest with return to the rest position in 4 steps, horizontal fixing, short arm, polypropylene pedals



	MATERIAL	PP-PA-AL
	COLOR	GREY ●
	WEIGHT	0,860 kg
	BREAKING	200 kg

HOMOLOGATION R118

DIMENSIONI - DIMENSIONS

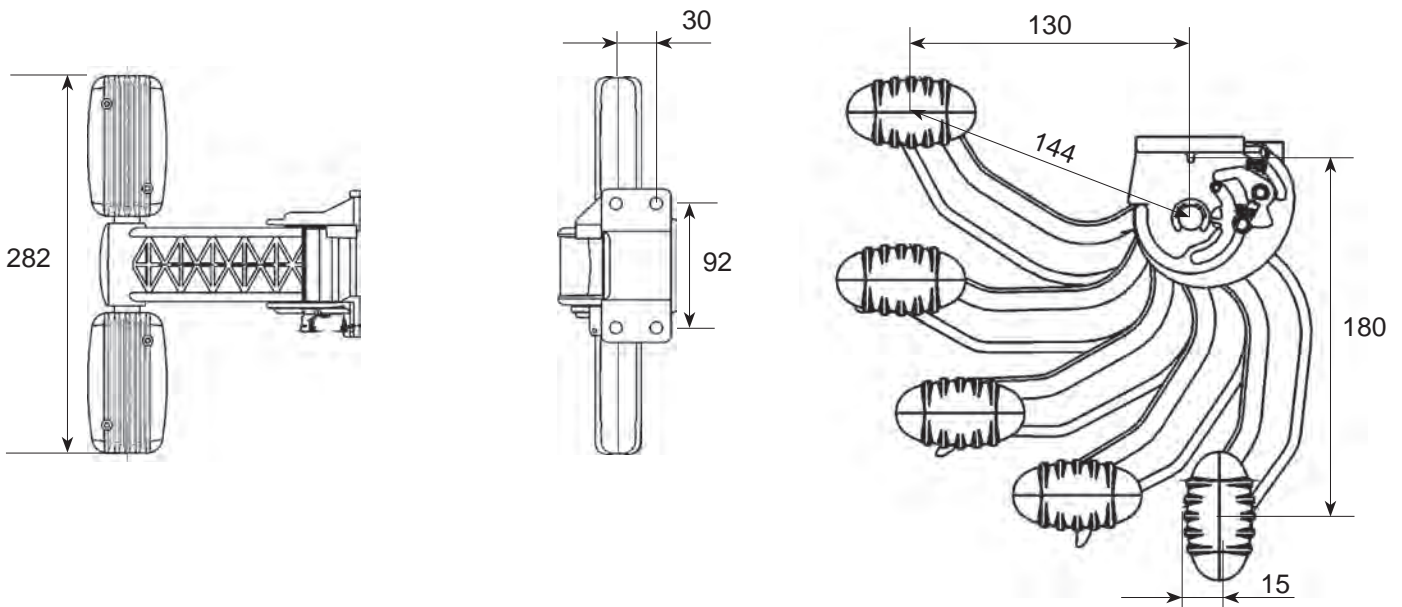

Accessori per appoggiapiedi V - Accessories for V footrest

608692M

Coperture laterali, per modelli: T, T3, V, BC, BC-VO, BC3





Side covers for model: T, T3, V, BC, BC-VO, BC3



HOMOLOGATION R118

	MATERIAL	PA
	COLOR	GREY ●
	MIN. ORDER	90 pcs
	UNIT	45 pcs
	WEIGHT	0,09 kg

Appoggiapiedi BC - BC footrest

	MATERIAL	PA-AL
	COLOR	GREY ●
	WEIGHT	0,855 kg
	BREAKING	200 kg

**6085520****ON DEMAND**

Appoggiapiedi con ritorno a 4 scatti, fissaggio orizzontale e braccio corto, pedali in poliammide



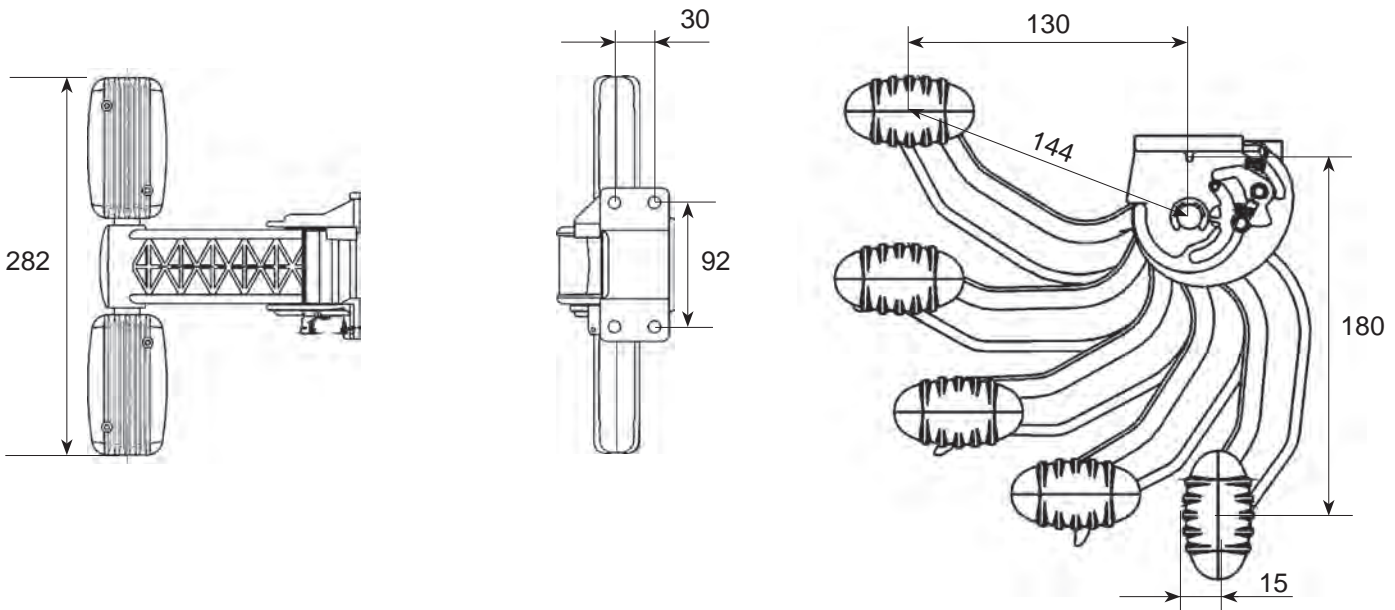

Footrest with return to the rest position in 4 steps, horizontal fixing, short arm, polyamide pedals

HOMOLOGATION R118

DIMENSIONI - DIMENSIONS



Accessori per appoggiapiedi BC - Accessories for BC footrest

	MATERIAL	PA
	COLOR	GREY ●
	MIN. ORDER	90 pcs
	UNIT	45 pcs
	WEIGHT	0,09 kg

**608692M**

Coperture laterali, per modelli: T, T3, V, BC, BC-VO, BC3

Side covers for model: T, T3, V, BC, BC-VO, BC3

HOMOLOGATION R118





Appoggiapiedi R - R footrest

608634N

ON DEMAND

Appoggiapiedi con ritorno a molla, fissaggio orizzontale

Footrest with return to the rest position by spring, horizontal fixing

	MATERIAL	PA-ABS-AL
	COLOR	GREY ●
	WEIGHT	1,250 kg
	BREAKING	200 kg



HOMOLOGATION R118

DIMENSIONI - DIMENSIONS

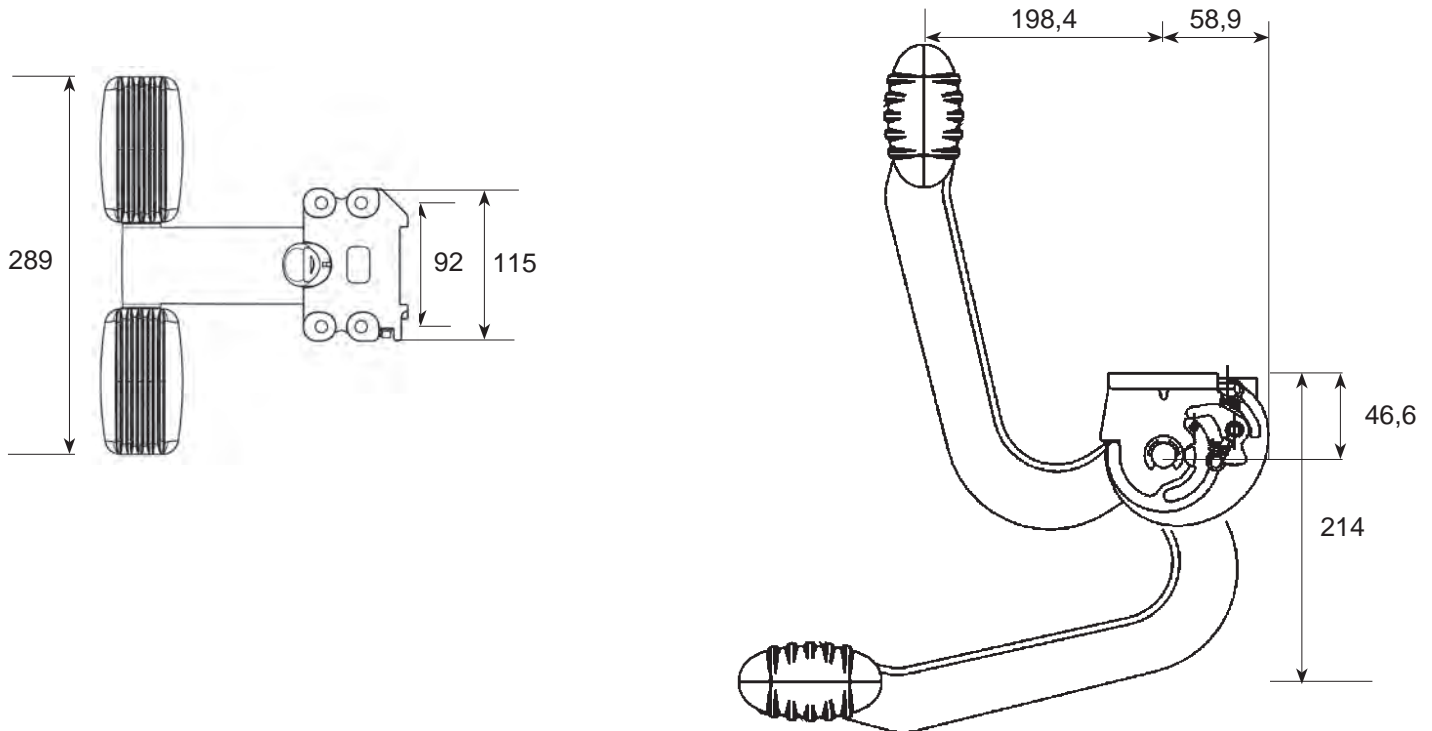

Appoggiapiedi K - K footrest



MATERIAL PA-ABS-AL



COLOR GREY●



WEIGHT 0,738 kg



BREAKING 200 kg

**6086947****ON DEMAND**

Appoggiapiedi con ritorno a 4 scatti, fissaggio orizzontale e braccio corto

Footrest with return to the rest position in 4 steps, horizontal fixing, short arm

HOMOLOGATION R118

DIMENSIONI - DIMENSIONS

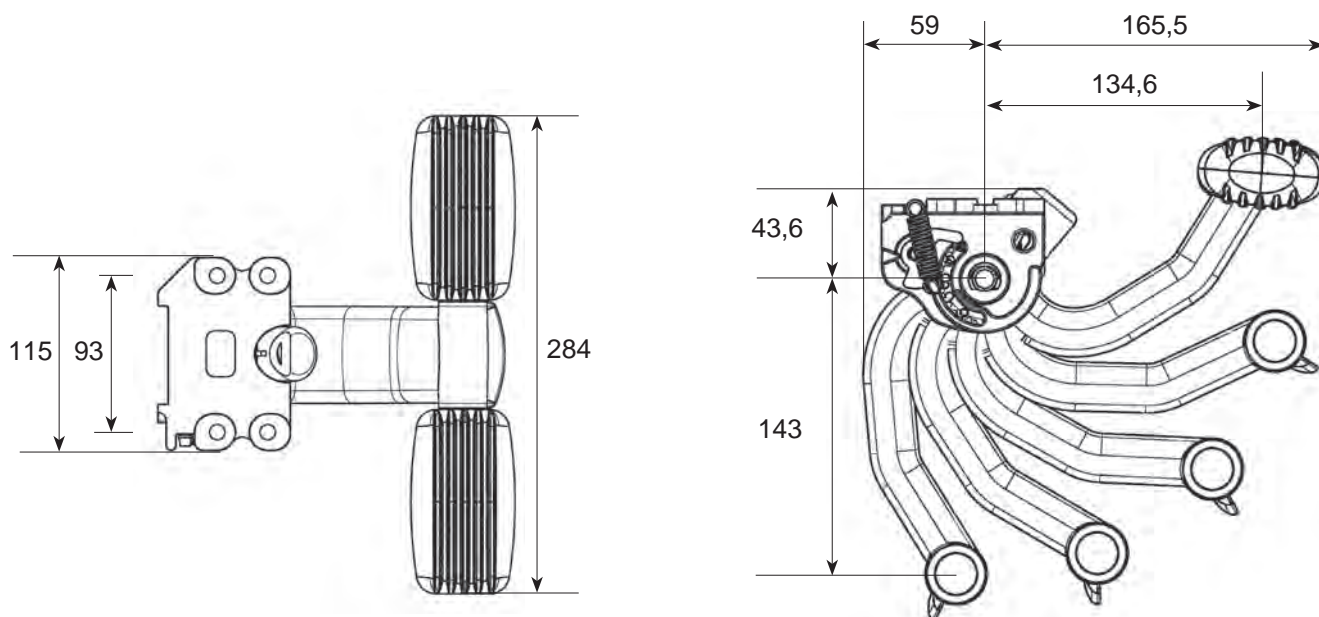

Appoggiapiedi VH - VH footrest

608703N

ON DEMAND

Appoggiapiedi con ritorno a 3 scatti, fissaggio orizzontale

Footrest with return to the rest position in 3 steps, horizontal fixing



MATERIAL PA-ABS-AL



COLOR GREY ●



WEIGHT 0,940 kg





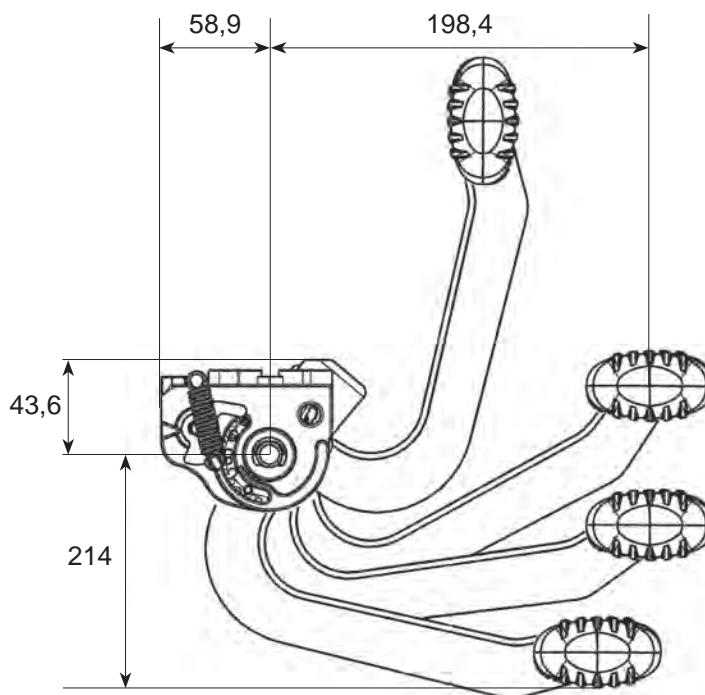
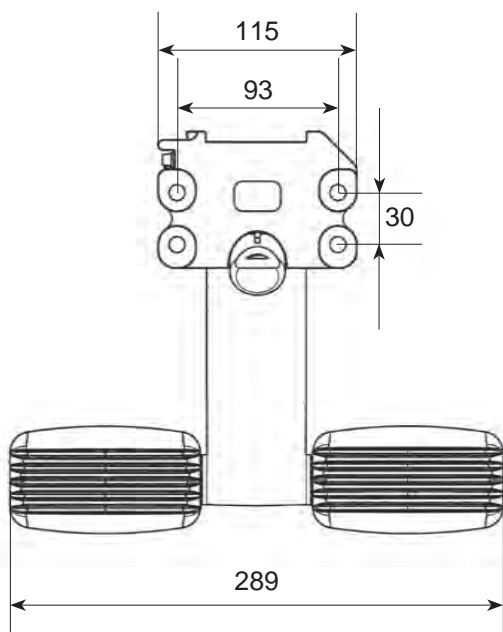

BREAKING 200 kg

HOMOLOGATION R118

DIMENSIONI - DIMENSIONS







Bracciolo monolitico lato sinistro - Monolithic armrest left hand

	MATERIAL	PA
	COLOR	BLACK ●
	MIN. ORDER	125 pcs
	UNIT	25 pcs
	WEIGHT	1,200 kg

**609032B**

Bracciolo monolitico per lato sinistro
Monolithic armrest, left hand version

Bracciolo monolitico lato destro - Monolithic armrest right hand

	MATERIAL	PA
	COLOR	BLACK ●
	MIN. ORDER	125 pcs
	UNIT	25 pcs
	WEIGHT	1,200 kg

**609033B**

Bracciolo monolitico per lato destro
Monolithic armrest, right hand version

DIMENSIONI - DIMENSIONS

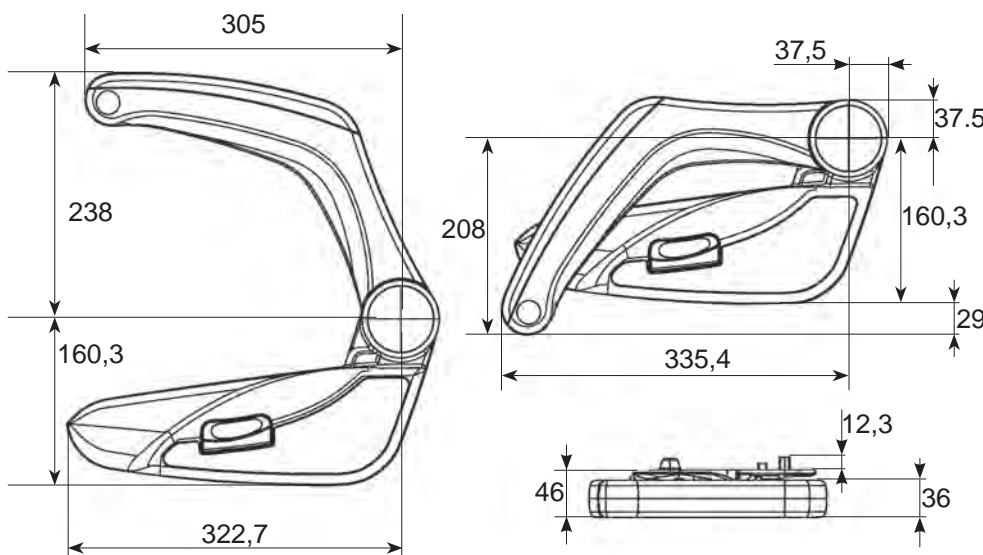



Prodotti costruiti in collaborazione con la ditta: Politecnica srl di Monsano (AN)

Design and engineering in collaboration with: Politecnica srl Monsano (AN), Italy

La distribuzione di questo articolo é soggetta a limiti territoriali. Vi preghiamo pertanto di verificare con il nostro ufficio commerciale la disponibilità dello stesso per la Vostra area geografica, prima di emettere l'ordine di acquisto

Distribution of this component is subject to territorial limits. We ask you kindly to check with our commercial department the availability of this component for your area prior to order submission

Bracciolo monolitico lato sinistro - Monolithic armrest left hand



	MATERIAL	PA
	COLOR	GREY ●
	WEIGHT	1,200 kg

**609032C****ON DEMAND**

Bracciolo monolitico per lato sinistro

Monolithic armrest, left hand version

Bracciolo monolitico lato destro - Monolithic armrest right hand

	MATERIAL	PA
	COLOR	GREY ●
	WEIGHT	1,200 kg

**609033C****ON DEMAND**

Bracciolo monolitico per lato destro

Monolithic armrest, right hand version

DIMENSIONI - DIMENSIONS

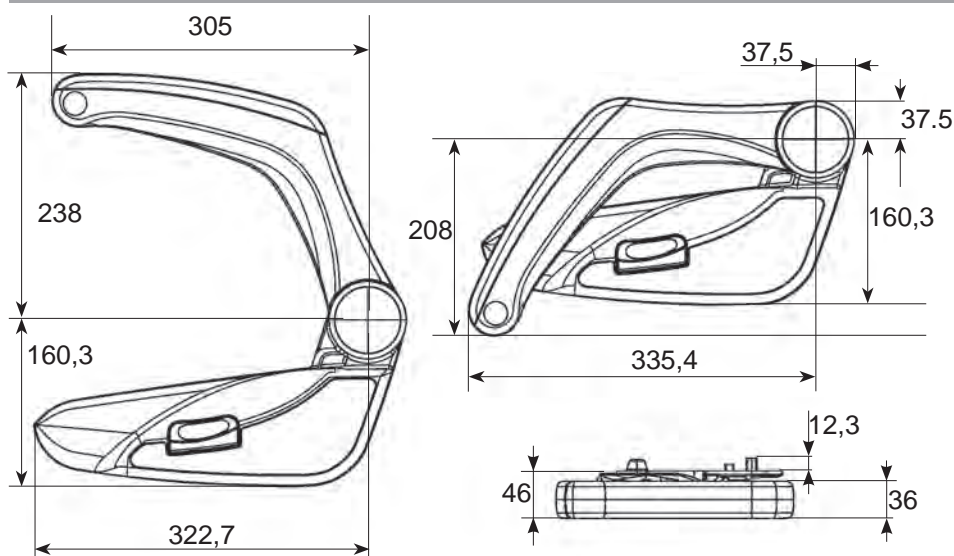



Prodotti costruiti in collaborazione con la ditta: Politecnica srl di Monsano (AN).

Design and engineering in collaboration with: Politecnica srl Monsano (AN), Italy

La distribuzione di questo articolo é soggetta a limiti territoriali. Vi preghiamo pertanto di verificare con il nostro ufficio commerciale la disponibilità dello stesso per la Vostra area geografica, prima di emettere l'ordine di acquisto

Distribution of this component is subject to territorial limits. We ask you kindly to check with our commercial department the availability of this component for your area prior to order submission

Accessori per bracciolo monolitico - Accesories for monolithic armrest

	MATERIAL	PA/ABS
	COLOR	BLACK ● METALLIC GREY ● NEUTRAL ○
	WEIGHT	0,023 kg

**609013B**

ON DEMAND

Mascherina per lato sinistro.
Left side armrest cover

**609015B**

ON DEMAND

Mascherina per lato destro
Right side armrest cover

**609013T**

ON DEMAND

Mascherina per lato sinistro
Left side armrest cover

**609015T**

ON DEMAND

Mascherina per lato destro
Right side armrest cover

**609013V**

ON DEMAND

Mascherina neutra per lato sinistro
predisposta per cubicatura
Left side neutral armrest cover
water transfer printing ready

**609015V**

ON DEMAND

Mascherina neutra per lato destro
predisposta per cubicatura
Right side neutral armrest cover
water transfer printing ready





Le mascherine accessorie di questa pagina sono utilizzabili sui braccioli: 609032B, 609033B, 609032M, 609033M, 609038B, 609039B, 609038M, 609039M.

These purpose-built armrest-covers can be fitted on the following ARMREST: 609032B, 609033B, 609032M, 609033M, 609038B, 609039B, 609038M, 609039M.

ESEMPI DI PERSONALIZZAZIONI - EXAMPLES OF CUSTOMIZED VERSIONS



Bracciolo composto lato sinistro - Built-up armrest right hand





	MATERIAL	PA
	COLOR	BLACK ●
	MIN. ORDER	125 pcs
	UNIT	25 pcs
	WEIGHT	1,540 kg

**609038B**

Bracciolo composto per lato sinistro

Built-up armrest, left hand version

Bracciolo composto lato destro - Built-up armrest right hand

	MATERIAL	PA
	COLOR	BLACK ●
	MIN. ORDER	125 pcs
	UNIT	25 pcs
	WEIGHT	1,540 kg

**609039B**

Bracciolo composto per lato destro

Built-up armrest, right hand version

DIMENSIONI - DIMENSIONS

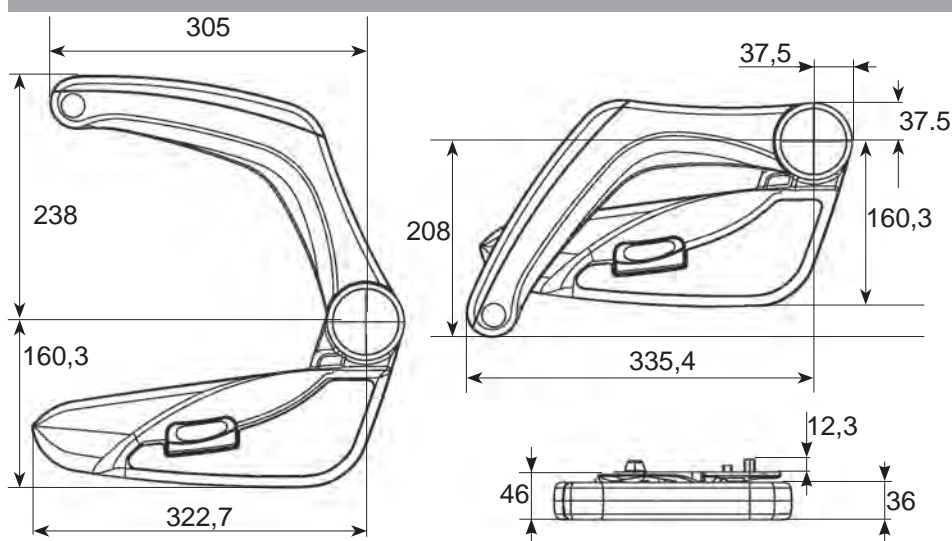

Prodotti costruiti in collaborazione con la ditta: Politecnica srl di Monsano (AN).

Design and engineering in collaboration with: Politecnica srl Monsano (AN), Italy



La distribuzione di questo articolo é soggetta a limiti territoriali. Vi preghiamo pertanto di verificare con il nostro ufficio commerciale la disponibilità dello stesso per la Vostra area geografica, prima di emettere l'ordine di acquisto

Distribution of this component is subject to territorial limits. We ask you kindly to check with our commercial department the availability of this component for your area prior to order submission

ESEMPI DI PERSONALIZZAZIONI - EXAMPLES OF CUSTOMIZED VERSIONS



Bracciolo Composto lato sinistro- Built-up armrest



	MATERIAL	PA
	COLOR	GREY ●
	WEIGHT	1,540 kg

**609038C****ON DEMAND**

Bracciolo composto per lato sinistro

Built-up armrest, left hand version

Bracciolo composto lato destro - Built-up armrest right hand

	MATERIAL	PA
	COLOR	GREY ●
	WEIGHT	1,540 kg

**609039C****ON DEMAND**

Bracciolo composto per lato destro

Built-up armrest, right hand version

DIMENSIONI - DIMENSIONS

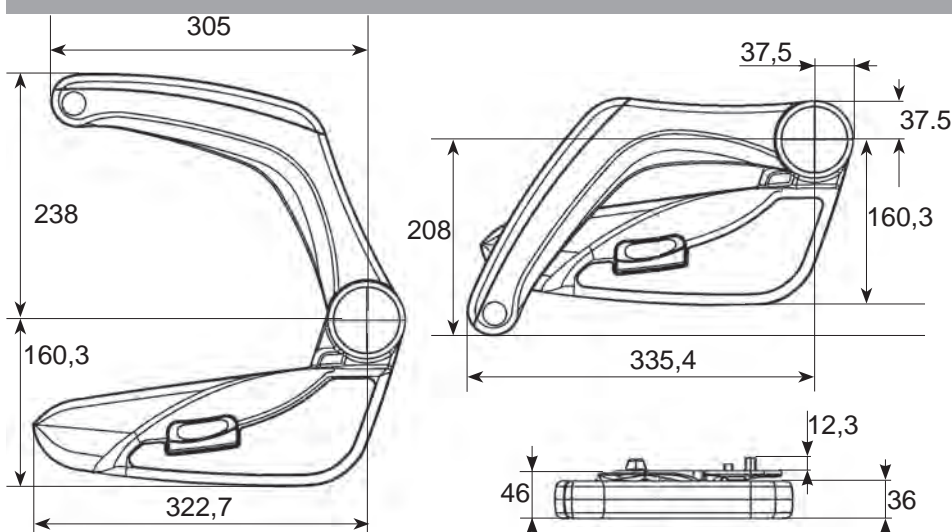

Prodotti costruiti in collaborazione con la ditta: Politecnica srl di Monsano (AN)

Design and engineering in collaboration with: Politecnica srl Monsano (AN), Italy



La distribuzione di questo articolo é soggetta a limiti territoriali. Vi preghiamo pertanto di verificare con il nostro ufficio commerciale la disponibilità dello stesso per la Vostra area geografica, prima di emettere l'ordine di acquisto

Distribution of this component is subject to territorial limits. We ask you kindly to check with our commercial department the availability of this component for your area prior to order submission

ESEMPI DI PERSONALIZZAZIONI - EXAMPLES OF CUSTOMIZED VERSIONS



Accessori per bracciolo composto- Accesories for Built-up armrest

	MATERIAL	PA/ABS
	COLOR	BLACK ●
		METALLIC GREY ●
		NEUTRAL ○
	WEIGHT	0,023 kg



609013B

ON DEMAND

Mascherina per lato sinistro.
Left side armrest cover



609015B

ON DEMAND

Mascherina per lato destro
Right side armrest cover



609013T

ON DEMAND

Mascherina per lato sinistro
Left side armrest cover



609015T

ON DEMAND

Mascherina per lato destro
Right side armrest cover



609013V

ON DEMAND

Mascherina neutra per lato sinistro
predisposta per cubicoltura
Left side neutral armrest cover
water transfer printing ready



609015V

ON DEMAND

Mascherina neutra per lato destro
predisposta per cubicoltura
Right side neutral armrest cover
water transfer printing ready

ESEMPI DI PERSONALIZZAZIONI - EXAMPLES OF CUSTOMIZED VERSIONS



Bracciolo Arco lato sinistro - Arco armrest left hand



MATERIAL PA



COLOR GREY ●



WEIGHT 0,880 kg

**609056M****ON DEMAND**

Bracciolo Arco per lato sinistro

Arco armrest, left hand version

Bracciolo Arco lato destro - Arco armrest right hand



MATERIAL PA



COLOR GREY ●



WEIGHT 0,880 kg

**609055M****ON DEMAND**

Bracciolo Arco per lato destro

Arco armrest, right hand version

DIMENSIONI - DIMENSIONS

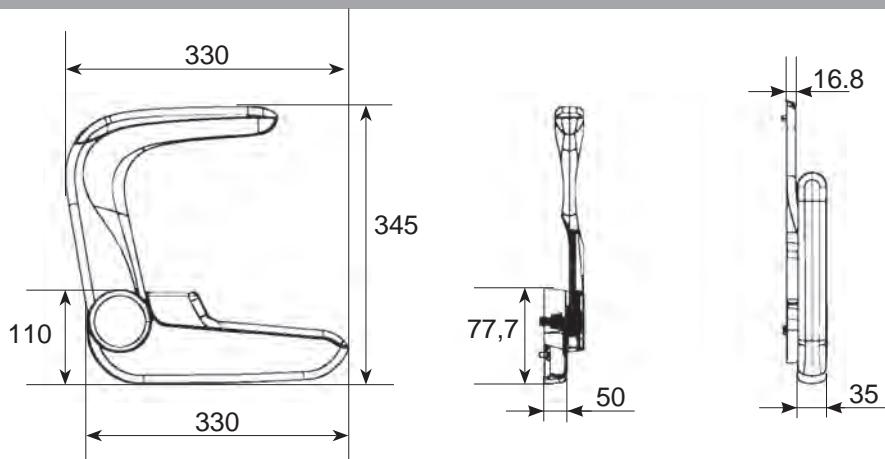





Prodotti costruiti in collaborazione con la ditta: Politecnica srl di Monsano (AN)

Design and engineering in collaboration with: Politecnica srl Monsano (AN), Italy

La distribuzione di questo articolo é soggetta a limiti territoriali. Vi preghiamo pertanto di verificare con il nostro ufficio commerciale la disponibilità dello stesso per la Vostra area geografica, prima di emettere l'ordine di acquisto

Distribution of this component is subject to territorial limits. We ask you kindly to check with our commercial department the availability of this component for your area prior to order submission



Bracciolo centrale composto - Built-up central armrest

	MATERIAL	PA
	COLOR	BLACK ●
	MIN. ORDER	120 pcs
	UNIT	40 pcs
	WEIGHT	0,42 kg

**609128B**

Bracciolo centrale composto

Built-up central armrest

	MATERIAL	PA
	COLOR	GREY ●
	WEIGHT	0,42 kg

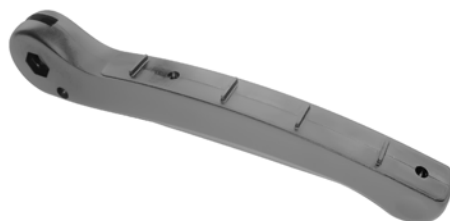
**609128C****ON DEMAND**

Bracciolo centrale composto

Built-up central armrest

DIMENSIONI - DIMENSIONS

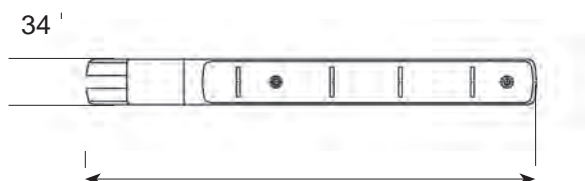

ESEMPI DI PERSONALIZZAZIONI - EXAMPLES OF CUSTOMIZED VERSIONS







Prodotti costruiti in collaborazione con la ditta: Politecnica srl di Monsano (AN).
Design and engineering in collaboration with: Politecnica srl Monsano (AN), Italy

La distribuzione di questo articolo é soggetta a limiti territoriali. Vi preghiamo pertanto di verificare con il nostro ufficio commerciale la disponibilità dello stesso per la Vostra area geografica, prima di emettere l'ordine di acquisto

Distribution of this component is subject to territorial limits. We ask you kindly to check with our commercial department the availability of this component for your area prior to order submission

Accessori per bracciolo centrale composto - Accesories for built-up central armrest

	MATERIAL	ABS/PA
	COLOR	BLACK ●
	COLOR	METALLIC GREY ●
	COLOR	NEUTRAL ○
	WEIGHT	0,070 kg



609019B



609119B

609119B

ON DEMAND

Terminale simmetrico
Symmetrical top

609019B

ON DEMAND

Terminale
Top



609019T



609119T

609119T

ON DEMAND

Terminale simmetrico
Symmetrical top

609019T

ON DEMAND

Terminale
Top

I terminali di questa pagina sono utilizzabili sui braccioli modello: 609038B, 609039B, 609038M, 609039M, 609128M, 609128B

The armrest-tops shown on this page can be fitted on the following ARMREST: 609038B, 609039B, 609038M, 609039M, 609128M, 609128B

**609119V**

ON DEMAND



Terminale simmetrico per cubicatura
Symmetrical top, water transfer printing ready

**609019V**

ON DEMAND

Terminale per cubicatura
Top, water transfer printing ready



Bracciolo centrale completo - Central armrest

	MATERIAL	PA
	COLOR	BLACK ●
	MIN. ORDER	144 pcs
	UNIT	48 pcs
	WEIGHT	0,421 kg

**609020B**

Bracciolo centrale completo

Central armrest

	MATERIAL	PA
	COLOR	GREY ●
	WEIGHT	0,421

**609020C****ON DEMAND**



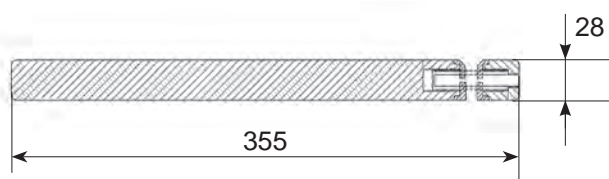
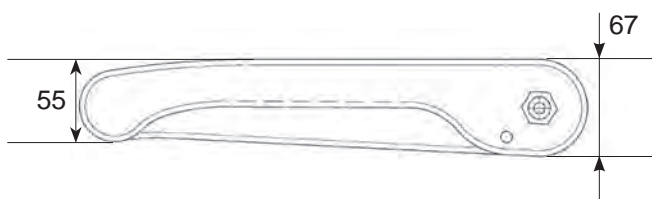

Bracciolo centrale completo

Central armrest

DIMENSIONI - DIMENSIONS





Bracciolo centrale completo corto - Small central armrest

	MATERIAL	PA
	COLOR	BLACK ●
	MIN. ORDER	100 pcs
	UNIT	50 pcs
	WEIGHT	0,300 kg

**675012B**

Bracciolo centrale completo corto

Small central armrest

	MATERIAL	PA
	COLOR	GREY ●
	WEIGHT	0,300 kg

**675012M****ON DEMAND**



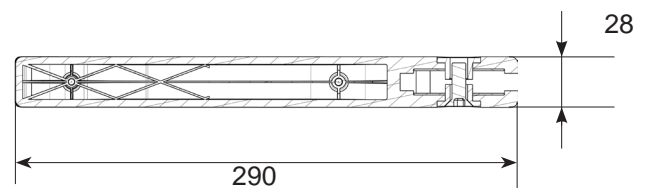
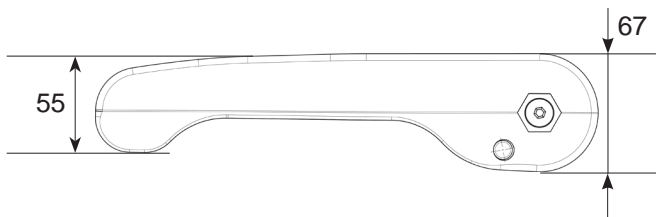

Bracciolo centrale completo corto

Small central armrest

DIMENSIONI - DIMENSIONS



Gancio doppio - Double curtain holder

	MATERIAL	PA
	COLOR	GREY ●
	MIN. ORDER	400 pcs
	UNIT	200 pcs
	WEIGHT	0,018



602063M



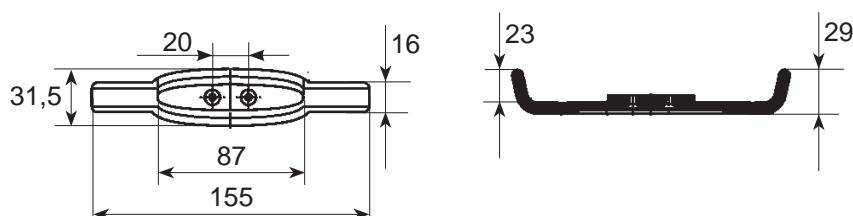

Gancio ferma tendina doppio
Double curtain holder

HOMOLOGATION R118

DIMENSIONI - DIMENSIONS



Gancio singolo - Single curtain holder

	MATERIAL	PA
	COLOR	GREY ●
	MIN. ORDER	400 pcs
	UNIT	200 pcs
	WEIGHT	0,014



602064M

Gancio ferma tendina singolo
Single curtain holder

HOMOLOGATION R118

DIMENSIONI - DIMENSIONS

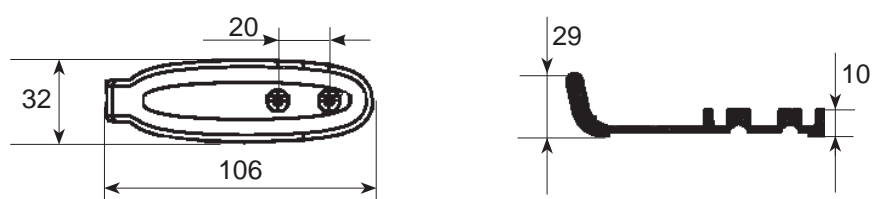

ACCESSORI - ACCESSORIES



MATERIAL PVC



COLOR YELLOW/METALLIC GREY



WEIGHT 0,004 kg

**603790D**

ON DEMAND

Marchio giallo coprivite

Yellow screw cap

603790G

Marchio grigio coprivite

Grey screw cap

DIMENSIONI - DIMENSIONS

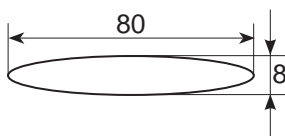

MATERIAL PVC



COLOR YELLOW ●

METALLIC GREY ●



WEIGHT 0,004 kg

**603790D**

ON DEMAND

Marchio giallo coprivite

Yellow screw cap

603790G

ON DEMAND



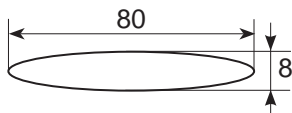

Marchio grigio coprivite

Grey screw cap

DIMENSIONI - DIMENSIONS







Disco Vinci I 17,5" - Vinci I wheel cover 17,5"

	MATERIAL	STAINLESS STEEL
	SURFACE	POLISHED
	MIN. ORDER	12 pcs
	UNIT	4 pcs
	WEIGHT	0,915 kg

**4052302**

Disco anteriore 17,5" h 80 mm,
superficie lucida



Front wheel cover 17,5" h 80 mm,
polished surface

	MATERIAL	STAINLESS STEEL
	SURFACE	POLISHED
	MIN. ORDER	12 pcs
	UNIT	4 pcs
	WEIGHT	0,915 kg

**4052502**

Disco posteriore 17,5"
superficie lucida

Rear wheel cover 17,5"
polished surface





	MATERIAL	STAINLESS STEEL
	SURFACE	MATT
	WEIGHT	0,915 kg

**4052506****ON DEMAND**

Disco posteriore 17,5"
superficie satinata

Rear wheel cover 17,5"
matt surface





Disco Vinci I 19,5" - Vinci I wheel cover 19,5"

	MATERIAL	STAINLESS STEEL
	SURFACE	POLISHED
	MIN. ORDER	12 pcs
	UNIT	4 pcs
	WEIGHT	1,100 kg

**4053002**

Disco anteriore 19,5" h 76 mm,
superficie lucida



Front wheel cover 19,5" h 76 mm,
polished surface

	MATERIAL	STAINLESS STEEL
	SURFACE	POLISHED
	MIN. ORDER	12 pcs
	UNIT	4 pcs
	WEIGHT	0,950 kg

**4053102**

Disco posteriore 19,5" superficie lucida



Rear wheel cover 19,5"
polished surface

	MATERIAL	STAINLESS STEEL
	SURFACE	POLISHED
	WEIGHT	1,150 kg

**4053302****ON DEMAND**

Disco anteriore 19,5" 8 fori h76 mm
superficie lucida

Front wheel cover 19,5" 8 hole h76 mm
polished surface





	MATERIAL	STAINLESS STEEL
	SURFACE	POLISHED
	WEIGHT	1,140 kg

**4053402****ON DEMAND**

Disco posteriore 19,5" 8 fori
superficie lucida

Rear wheel cover 19,5" 8 hole
polished surface

Disco Vinci I 22,5" - Vinci I wheel cover 22,5"

	MATERIAL	STAINLESS STEEL
	SURFACE	POLISHED
	MIN. ORDER	12 pcs
	UNIT	4 pcs
	WEIGHT	1,310 kg

**4050002**

Disco anteriore 22,5" h 92 mm,
superficie lucida

Front wheel cover 22,5" h 92 mm,
polished surface

	MATERIAL	STAINLESS STEEL
	SURFACE	MATT
	MIN. ORDER	36 pcs
	UNIT	4 pcs
	WEIGHT	1,310 kg

**4050006**

Disco anteriore 22,5" h 92 mm
superficie satinata

Front wheel cover 22,5" h 92 mm
matt surface





	MATERIAL	STAINLESS STEEL
	SURFACE	POLISHED
	MIN. ORDER	12 pcs
	UNIT	4 pcs
	WEIGHT	1,300 kg

**4054002**

Disco anteriore 22,5" h 65 mm
superficie lucida

Front wheel cover 22,5" h 65 mm
polished surface





Disco Vinci I 22,5" - Vinci I wheel cover 22,5"

	MATERIAL	STAINLESS STEEL
	SURFACE	POLISHED
	MIN. ORDER	12 pcs
	UNIT	4 pcs
	WEIGHT	1,480 kg

**4050202**

Disco posteriore 22,5"
superficie lucida



Rear wheel cover 22,5"
polished surface

	MATERIAL	STAINLESS STEEL
	SURFACE	MATT
	MIN. ORDER	36 pcs
	UNIT	4 pcs
	WEIGHT	1,480 kg

**4050206**

Disco posteriore 22,5"
superficie satinata

Rear wheel cover 22,5"
matt surface

	MATERIAL	STAINLESS STEEL
	SURFACE	MATT
	WEIGHT	1,530 kg

**4054006****ON DEMAND**

Disco anteriore 22,5" h 65 mm
superficie satinata

Front wheel cover 22,5" h 65 mm
matt surface.

Accessori per dischi copriuota - Accessories for wheel covers



MATERIAL PC-ABS



COLOR BLACK



MIN. ORDER 32 pcs



UNIT 16 pcs



WEIGHT 0,086 kg

**4051505**

Coppetta centrale Vinci piccola

Small Vinci central cap

Ø 162 mm



MATERIAL PC-ABS



COLOR BLACK



MIN. ORDER 20 pcs



UNIT 20 pcs



WEIGHT 0,148 kg

**4056315**Coppetta centrale Vinci larga
(solo per dischi da 22,5")

Large Vinci central cap (only for 22,5")

Ø 230 mm



MATERIAL POM



COLOR BLACK



MIN. ORDER 100 pcs



UNIT 100 pcs



WEIGHT 0,052 kg

**403955B**

tassello Vinci per fissaggio

Vinci fixing

2.1

DISCO VINCI II - VINCI II WHEEL COVER

Disco Vinci II 19,5" - Vinci II wheel cover 19,5"



MATERIAL STAINLESS STEEL



SURFACE POLISHED



MIN. ORDER 12 pcs



UNIT 4 pcs



WEIGHT 1,095 kg



4052802

ON DEMAND

Disco anteriore 19,5" h 76 mm,
superficie lucida

Front wheel cover 19,5" h 76 mm,
polished surface



MATERIAL STAINLESS STEEL



SURFACE POLISHED



MIN. ORDER 12 pcs



UNIT 4 pcs



WEIGHT 1,095 kg



4052902

ON DEMAND

Disco posteriore 19,5"
superficie lucida

Rear wheel cover 19,5"
polished surface



Disco Vinci II 22,5" - Vinci II wheel cover 22,5"

	MATERIAL	STAINLESS STEEL
	SURFACE	POLISHED
	MIN. ORDER	12 pcs
	UNIT	4 pcs
	WEIGHT	1,31 kg

**4050302**

Disco anteriore 22,5" h 92 mm
superficie lucida

Front wheel cover 22,5" h 92 mm
polished surface

	MATERIAL	STAINLESS STEEL
	SURFACE	POLISHED
	MIN. ORDER	12 pcs
	UNIT	4 pcs
	WEIGHT	1,178 kg

**4050402**

Disco posteriore 22"
superficie lucida

Rear wheel cover 22"
polished surface

Accessori per dischi copriruota - Accessories for wheel covers



MATERIAL PC-BS



COLOR BLACK



MIN. ORDER 32 pcs



UNIT 16 pcs



WEIGHT 0,086 kg

**4051505**

Coppetta centrale Vinci piccola

Small Vinci central cap

Ø 162 mm



MATERIAL PC-BS



COLOR BLACK



MIN. ORDER 20 pcs



UNIT 20 pcs



WEIGHT 0,148 kg

**4056315**Coppetta centrale Vinci larga
(solo per dischi da 22,5")

Large Vinci central cap (only for 22,5")

Ø 230 mm



MATERIAL POM



COLOR BLACK



MIN. ORDER 100 pcs



UNIT 100 pcs



WEIGHT 0,052 kg

**403955B**

tassello Vinci per fissaggio

Vinci fixing

Disco Vinci I Classic 22.5" - Vinci I Classic wheel cover 22.5"

	MATERIAL	STAINLESS STEEL
	SURFACE	POLISHED
	MIN. ORDER	12 pcs
	UNIT	4 pcs
	WEIGHT	1,460 kg



4056432

Disco anteriore 22,5" h 92 mm
superficie lucida

Front wheel cover 22,5" h 92 mm
Polished surface

CLASSIC
with brackets
included

	MATERIAL	STAINLESS STEEL
	SURFACE	POLISHED
	MIN. ORDER	12 pcs
	UNIT	4 pcs
	WEIGHT	1,514 kg



4056442

Disco posteriore 22,5"
superficie lucida

Rear wheel cover 22,5"
Polished surface

CLASSIC
with brackets
included

2.1 DISCO VINCI II CLASSIC - VINCI II CLASSIC WHEEL COVER

Disco Vinci II Classic 19.5" - Vinci II Classic wheel cover 19.5"



MATERIAL STAINLESS STEEL



SURFACE POLISHED



WEIGHT 1,071 kg



4052812

ON DEMAND

Disco anteriore 19,5" h 76 mm
superficie lucida

Front wheel cover 19,5" h 76 mm
Polished surface

CLASSIC
with brackets
not included



MATERIAL STAINLESS STEEL



SURFACE POLISHED



WEIGHT 0,985 kg



4052912

ON DEMAND

Disco posteriore 19,5"
superficie lucida

Rear wheel cover 19,5"
Polished surface

CLASSIC
with brackets
not included

Disco Vinci II Classic 22,5" - Vinci II Classic wheel cover 22,5"

	MATERIAL	STAINLESS STEEL
	SURFACE	POLISHED
	MIN. ORDER	12 pcs
	UNIT	4 pcs
	WEIGHT	1,460 kg







4056342

Disco anteriore 22,5" h 92 mm
superficie lucida

Front wheel cover 22,5" h 92 mm
Polished surface

CLASSIC
with brackets
included

	MATERIAL	STAINLESS STEEL
	SURFACE	POLISHED
	MIN. ORDER	12 pcs
	UNIT	4 pcs
	WEIGHT	1,514 kg



4056352





Disco posteriore 22,5"
superficie lucida

Rear wheel cover 22,5"
Polished surface

CLASSIC
with brackets
included

2.1 DISCO VINCI II CLASSIC - VINCI II CLASSIC WHEEL COVER

Accessori per dischi copriruota - Accessories for wheel covers

	MATERIAL	PC-ABS
	COLOR	BLACK
	MIN. ORDER	32 pcs
	UNIT	16 pcs
	WEIGHT	0,088 kg







4051505

Coppetta centrale Vinci piccola

Small Vinci central cap

Ø 162 mm

	MATERIAL	PC-ABS
	COLOR	BLACK
	MIN. ORDER	20 pcs
	UNIT	20 pcs
	WEIGHT	0,148 kg



4056315

Coppetta centrale Vinci larga
solo per dischi da 22"5

Small Vinci central cap (only for 22,5"

Ø 230 mm

STAFFE PER DISCHI - BRACKETS FOR WHEEL COVERS







Staffe per l'applicazione dei dischi Vinci Classic per tutti i tipi di ruote anteriori e posteriori da 16" a 22,5". Per la scelta del tipo di staffa si consiglia di contattare il servizio clienti o compilare il modulo specifico allegato al catalogo

Brackets for the application of Vinci Classic wheel covers for all types from 16" to 22,5" front and rear wheels.

For choosing the type of bracket it is recommended to contact customer service or fill in the specific form attached to the catalog





Disco Rally 16" - Rally wheel cover 16"

	MATERIAL	STAINLESS STEEL
	SURFACE	POLISHED
	MIN. ORDER	20 pcs
	UNIT	4 pcs
	WEIGHT	0,780 kg

**4015002**

Disco anteriore 16" (440x70)
superficie lucida

front wheel cover 14" (440x70)
Polished surface





	MATERIAL	STAINLESS STEEL
	SURFACE	POLISHED
	MIN. ORDER	20 pcs
	UNIT	4 pcs
	WEIGHT	0,780 kg

**4015752**

Disco anteriore 16"
superficie lucida

Front wheel cover 16"
Polished surface

FIAT DUCATO

	MATERIAL	STAINLESS STEEL
	SURFACE	POLISHED
	MIN. ORDER	20 pcs
	UNIT	4 pcs
	WEIGHT	0,826 kg





**4015602**

Disco anteriore 16" (440x70)
superficie lucida

Front wheel cover 16" (440x70)
Polished surface

**IVECO EURO CARGO
DAILY 59-12**

Disco Rally 16" - Rally wheel cover 16"





	MATERIAL	STAINLESS STEEL
	SURFACE	POLISHED
	MIN. ORDER	20 pcs
	UNIT	4 pcs
	WEIGHT	0,796 kg

**4015702**

Disco posteriore 16"
superficie lucida

Rear wheel cover 16"
Polished surface





**IVECO EUROCARGO
DAILY 59-12**

	MATERIAL	STAINLESS STEEL
	SURFACE	POLISHED
	MIN. ORDER	20 pcs
	UNIT	4 pcs
	WEIGHT	0,780 kg

**4015102**

Disco posteriore 16" (440x33)
superficie lucida

Rear wheel cover 14" (440x33)
Polished surface

	MATERIAL	STAINLESS STEEL
	SURFACE	POLISHED
	MIN. ORDER	20 pcs
	UNIT	4 pcs
	WEIGHT	0,770 kg

**4015762**

Disco posteriore 16"
superficie lucida

Rear wheel cover 16"
Polished surface

FIAT DUCATO

Accessori per dischi copriuota - Accessories for wheel covers

**4015505**

Monogramma centrale.

Central cap

**4013505**

Distanziale per dischi da 14" e 16"

Spacer for 14" and 16" wheel covers

**4009605**

tassello rotondo per staffa

Spacer for bracket

**4010125**

Distanziale per dischi da 15"

Spacer for 15" wheel covers

0402130

ON DEMAND

Vite 8 x 25 mm
Screw 8 x 25 mm**0402140**

ON DEMAND

Vite 8 x 30 mm
Screw 8 x 30 mm**0402150**

ON DEMAND

Vite 8 x 40 mm
Screw 8 x 40 mm**4001301**

ON DEMAND

Chiave 5 mm
Key 5 mm

STAFFE PER DISCHI - BRACKETS FOR WHEEL COVERS



Staffe per l'applicazione dei dischi Vinci Classic per tutti i tipi di ruote anteriori e posteriori da 16" a 22,5". Per la scelta del tipo di staffa si consiglia di contattare il servizio clienti o compilare il modulo specifico allegato al catalogo



Brackets for the application of Vinci Classic wheel covers for all types from 16" to 22,5" front and rear wheels. For choosing the type of bracket it is recommended to contact customer service or fill in the specific form attached to the catalog



2.1

DISCO EASY - EASY WHEEL COVER

Disco Easy 15" - Easy wheel cover 15"

	MATERIAL	STAINLESS STEEL
	SURFACE	POLISHED
	WEIGHT	0,600 kg







4944472

ON DEMAND

Disco posteriore 15"
fissaggio a scatto

Rear wheel cover 15"
snap fixing

Accessori per dischi copriruota - Accessories for wheel covers

	MATERIAL	PC-ABS
	COLOR	BLACK
	MIN. ORDER	32 pcs
	UNIT	32 pcs
	WEIGHT	0,088 kg



4051505

Coppetta centrale Vinci piccola

Small Vinci central cap

Ø 162 mm

FISSAGGI - FIXING

Fissaggio a molla
Spring fixing



Fissaggio a molla
Spring fixing



Fissaggio a scatto
Snap fixing



Disco Compact 15" - Compact wheel cover 15"



MATERIAL STAINLESS STEEL



SURFACE POLISHED



WEIGHT 0,674 kg

**4944102****ON DEMAND**Disco 15" per ruote post. per furgoni.
fissaggio a scattoWheel cover 15" for rear wheel on vans.
snap fixing

Accessori per dischi copriuota - Accessories for wheel covers

**4015505**

Monogramma centrale.

Central cap

4937005**ON DEMAND**tassello per molle metalliche
Spacer for springs**4936402****ON DEMAND**Molla metallica
Metal spring

Disco Columbus 16" - Columbus wheel cover 16"



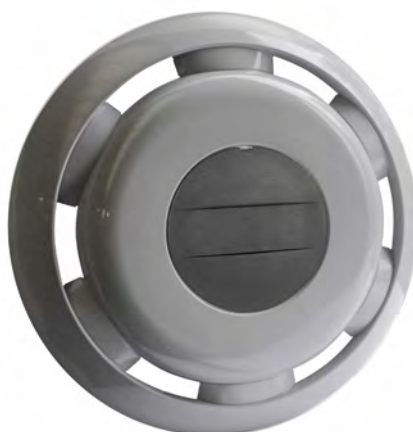

MATERIAL	ABS
SURFACE	RAL 7042
MIN. ORDER	12 pcs
UNIT	4 pcs
WEIGHT	0,986 kg



420066H

Disco anteriore 16" coppetta Vinci
Front wheel cover 16" Vinci cap

**READY
TO PAINT**



 MATERIAL	ABS
 SURFACE	RAL 7042
 MIN. ORDER	12 pcs
 UNIT	4 pcs
 WEIGHT	0,986 kg



420067H

Disco posteriore 16" coppetta Vinci
Rear wheel cover 16" Vinci cap

**READY
TO PAINT**

 MATERIAL	ABS
 SURFACE	SILVER
 MIN. ORDER	12 pcs
 UNIT	4 pcs
 WEIGHT	0,986 kg

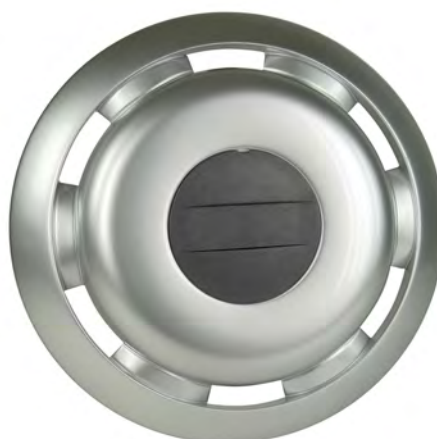

4200661

Disco anteriore 16" coppetta Vinci
Front wheel cover 16" Vinci cap

 MATERIAL	ABS
 SURFACE	SILVER
 MIN. ORDER	12 pcs
 UNIT	4 pcs
 WEIGHT	0,986 kg



4200671

Disco posteriore 16" coppetta Vinci
Rear wheel cover 16" Vinci cap

Disco Columbus 16" - Columbus wheel cover 16"



MATERIAL ABS



SURFACE CHROMED



MIN. ORDER 12 pcs



UNIT 4 pcs



WEIGHT 0,986 kg

**420066Y**

Disco anteriore 16" coppetta Vinci

Front wheel cover 16" Vinci cap



MATERIAL ABS



SURFACE CHROMED



MIN. ORDER 12 pcs



UNIT 4 pcs





WEIGHT 0,986 kg

**420067Y**

Disco posteriore 16" coppetta Vinci

Rear wheel cover 16" Vinci cap

Disco Columbus 16" - Columbus wheel cover 16"

	MATERIAL	ABS
	SURFACE	RAL 7042
	MIN. ORDER	12 pcs
	UNIT	4 pcs
	WEIGHT	0,986 kg

**420068H**

Disco anteriore 16" coppetta metallica
Front wheel cover 16" metallic cap

READY TO PAINT

	MATERIAL	ABS
	SURFACE	RAL 7042
	MIN. ORDER	12 pcs
	UNIT	4 pcs
	WEIGHT	0,986 kg

**420069H**

Disco posteriore 16" coppetta metallica
Rear wheel cover 16" metallic cap

READY TO PAINT

	MATERIAL	ABS
	SURFACE	SILVER
	MIN. ORDER	12 pcs
	UNIT	4 pcs
	WEIGHT	0,89 kg

**4200681**

Disco anteriore 16" coppetta metallica
Front wheel cover 16" metallic cap

	MATERIAL	ABS
	SURFACE	SILVER
	MIN. ORDER	12 pcs
	UNIT	4 pcs
	WEIGHT	0,986 kg

**4200691**

Disco posteriore 16" coppetta metallica
Rear wheel cover 16" metallic cap

Disco Columbus 16" - Columbus wheel cover 16"



MATERIAL ABS



SURFACE CHROMED



MIN. ORDER 12 pcs



UNIT 4 pcs



WEIGHT 0,986 kg

**420068Y**

Disco anteriore 16" coppetta metallica

Front wheel cover 16" metallic cap



MATERIAL ABS



SURFACE CHROMED



MIN. ORDER 12 pcs



UNIT 4 pcs







WEIGHT 0,986 kg

**420069Y**

Disco posteriore 16" coppetta metallica

Rear wheel cover 16" metallic cap

Disco Columbus 17,5" - Columbus wheel cover 17,5"

	MATERIAL	ABS
	SURFACE	RAL 7042
	MIN. ORDER	12 pcs
	UNIT	4 pcs
	WEIGHT	0,970 kg







420043H

Disco anteriore 17,5" coppetta Vinci

Front wheel cover 17,5" Vinci cap

READY TO PAINT

	MATERIAL	ABS
	SURFACE	RAL 7042
	MIN. ORDER	12 pcs
	UNIT	4 pcs
	WEIGHT	0,970 kg







420044H

Disco posteriore 17,5" coppetta Vinci

Rear wheel cover 17,5" Vinci cap

READY TO PAINT

	MATERIAL	ABS
	SURFACE	SILVER
	MIN. ORDER	12 pcs
	UNIT	4 pcs
	WEIGHT	0,970 kg

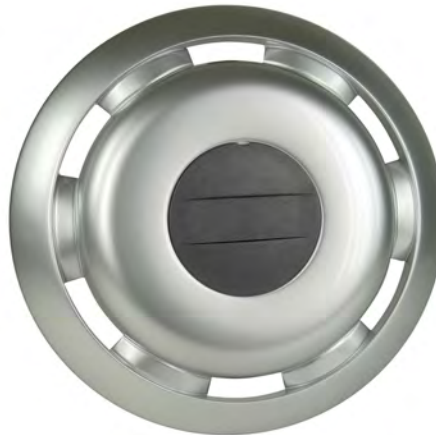

4200431

Disco anteriore 17,5" coppetta Vinci

Front wheel cover 17,5" Vinci cap

	MATERIAL	ABS
	SURFACE	SILVER
	MIN. ORDER	12 pcs
	UNIT	4 pcs
	WEIGHT	0,970 kg







4200441

Disco posteriore 17,5" coppetta Vinci

Rear wheel cover 17,5" Vinci cap





Disco Columbus 17,5" - Columbus wheel cover 17,5"

	MATERIAL	ABS
	SURFACE	CHROMED
	MIN. ORDER	12 pcs
	UNIT	4 pcs
	WEIGHT	0,970 kg

**420043Y**

Disco anteriore 17,5" coppetta Vinci

Front wheel cover 17,5" Vinci cap





	MATERIAL	ABS
	SURFACE	CHROMED
	MIN. ORDER	12 pcs
	UNIT	4 pcs
	WEIGHT	0,970 kg

**420044Y**

Disco posteriore 17,5" coppetta Vinci

Rear wheel cover 17,5" Vinci cap

Disco Columbus 17,5" - Columbus wheel cover 17,5"

	MATERIAL	ABS
	SURFACE	RAL 7042
	MIN. ORDER	12 pcs
	UNIT	4 pcs
	WEIGHT	0,970 kg







420045H

Disco anteriore 17,5" coppetta metallica

Front wheel cover 17,5" metallic cap

READY TO PAINT

	MATERIAL	ABS
	SURFACE	RAL 7042
	MIN. ORDER	12 pcs
	UNIT	4 pcs
	WEIGHT	0,970 kg







420046H

Disco posteriore 17,5" coppetta metallica

Rear wheel cover 17,5" metallic cap

READY TO PAINT



	MATERIAL	ABS
	SURFACE	SILVER
	MIN. ORDER	12 pcs
	UNIT	4 pcs
	WEIGHT	0,970 kg



4200451

Disco anteriore 17,5" coppetta metallica

Front wheel cover 17,5" metallic cap

	MATERIAL	ABS
	SURFACE	SILVER
	MIN. ORDER	12 pcs
	UNIT	4 pcs
	WEIGHT	0,970 kg







4200461

Disco posteriore 17,5" coppetta metallica

Rear wheel cover 17,5" metallic cap





Disco Columbus 17,5" - Columbus wheel cover 17,5"

	MATERIAL	ABS
	SURFACE	CHROMED
	MIN. ORDER	12 pcs
	UNIT	4 pcs
	WEIGHT	0,970 kg

**420045Y**

Disco anteriore 17,5" coppetta metallica

Front wheel cover 17,5" metallic cap



	MATERIAL	ABS
	SURFACE	CHROMED
	MIN. ORDER	12 pcs
	UNIT	4 pcs
	WEIGHT	0,970 kg

**420046Y**

Disco posteriore 17,5" coppetta metallica

Rear wheel cover 17,5" metallic cap

Disco Columbus 22,5" - Columbus wheel cover 22,5"

	MATERIAL	ABS
	SURFACE	RAL 7042
	MIN. ORDER	12 pcs
	UNIT	4 pcs
	WEIGHT	1,900 kg



420009H

Disco anteriore 22,5" coppetta Vinci piccola

Front wheel cover 22,5" small Vinci cap

READY TO PAINT

	MATERIAL	ABS
	SURFACE	RAL 7042
	MIN. ORDER	12 pcs
	UNIT	4 pcs
	WEIGHT	1,600 kg



420012H

Disco posteriore 22,5" coppetta Vinci piccola

Rear wheel cover 22,5" small Vinci cap

READY TO PAINT

	MATERIAL	ABS
	SURFACE	SILVER
	MIN. ORDER	12 pcs
	UNIT	4 pcs
	WEIGHT	1,900 kg



4200091

Disco anteriore 22,5" coppetta Vinci piccola

Front wheel cover 22,5" small Vinci cap

	MATERIAL	ABS
	SURFACE	SILVER
	MIN. ORDER	12 pcs
	UNIT	4 pcs
	WEIGHT	1,600 kg







4200121

Disco posteriore 22,5" coppetta Vinci piccola

Rear wheel cover 22,5" small Vinci cap





Disco Columbus 22,5" - Columbus wheel cover 22,5"

	MATERIAL	ABS
	SURFACE	CHROMED
	MIN. ORDER	12 pcs
	UNIT	4 pcs
	WEIGHT	1,90 kg

**420009Y**

Disco anteriore 22,5" coppetta Vinci piccola

Front wheel cover 22,5" small Vinci cap





	MATERIAL	ABS
	SURFACE	CHROMED
	MIN. ORDER	12 pcs
	UNIT	4 pcs
	WEIGHT	1,60 kg

**420012Y**

Disco posteriore 22,5" coppetta Vinci piccola

Rear wheel cover 22,5" small Vinci cap

Disco Columbus 22,5" - Columbus wheel cover 22,5"

	MATERIAL	ABS
	SURFACE	RAL 7042
	MIN. ORDER	12 pcs
	UNIT	4 pcs
	WEIGHT	1,90 kg







420010H

Disco anteriore 22,5" coppetta Vinci grande

Front wheel cover 22,5" large Vinci cap

READY TO PAINT

	MATERIAL	ABS
	SURFACE	RAL 7042
	MIN. ORDER	12 pcs
	UNIT	4 pcs
	WEIGHT	1,60 kg





420013H

Disco posteriore 22,5" coppetta Vinci grande

Rear wheel cover 22,5" large Vinci cap

READY TO PAINT

	MATERIAL	ABS
	SURFACE	SILVER
	MIN. ORDER	12 pcs
	UNIT	4 pcs
	WEIGHT	1,90 kg



4200101

Disco anteriore 22,5" coppetta Vinci grande

Front wheel cover 22,5" large Vinci cap

	MATERIAL	ABS
	SURFACE	SILVER
	MIN. ORDER	12 pcs
	UNIT	4 pcs
	WEIGHT	1,60 kg







4200131

Disco posteriore 22,5" coppetta Vinci grande

Rear wheel cover 22,5" large Vinci cap





Disco Columbus 22,5" - Columbus wheel cover 22,5"

	MATERIAL	ABS
	SURFACE	CHROMED
	MIN. ORDER	12 pcs
	UNIT	4 pcs
	WEIGHT	1,900kg

**420010Y**

Disco anteriore 22,5" coppetta Vinci grande

Front wheel cover 22,5" large Vinci cap

	MATERIAL	ABS
	SURFACE	CHROMED
	MIN. ORDER	12 pcs
	UNIT	4 pcs
	WEIGHT	1,600 kg

**420013Y**

Disco posteriore 22,5" coppetta Vinci grande

Rear wheel cover 22,5" large Vinci cap

Disco Columbus 22,5" - Columbus wheel cover 22,5"



	MATERIAL	ABS
	SURFACE	RAL 7042
	MIN. ORDER	12 pcs
	UNIT	4 pcs
	WEIGHT	1,900 kg



420011H

Disco anteriore 22,5" coppetta metallica
Front wheel cover 22,5" metallic cap

READY TO PAINT



	MATERIAL	ABS
	SURFACE	RAL 7042
	MIN. ORDER	12 pcs
	UNIT	4 pcs
	WEIGHT	1,600 kg



420014H

Disco posteriore 22,5" coppetta metallica
Rear wheel cover 22,5" metallic cap

READY TO PAINT

	MATERIAL	ABS
	SURFACE	SILVER
	MIN. ORDER	12 pcs
	UNIT	4 pcs
	WEIGHT	1,900 kg



4200111

Disco anteriore 22,5" coppetta metallica
Front wheel cover 22,5" metallic cap

	MATERIAL	ABS
	SURFACE	SILVER
	MIN. ORDER	12 pcs
	UNIT	4 pcs
	WEIGHT	1,600 kg







4200141

Disco posteriore 22,5" coppetta metallica
Rear wheel cover 22,5" metallic cap

2.2

DISCHI COLUMBUS - COLUMBUS WHEEL COVERS

Disco Columbus 22,5" - Columbus wheel cover 22,5"





	MATERIAL	ABS
	SURFACE	CHROMED
	MIN. ORDER	12 pcs
	UNIT	4 pcs
	WEIGHT	1,900 kg



420011Y

Disco anteriore 22,5" coppetta metallica

Front wheel cover 22,5" metallic cap

	MATERIAL	ABS
	SURFACE	CHROMED
	MIN. ORDER	12 pcs
	UNIT	4 pcs
	WEIGHT	1,600 kg



420014Y

Disco posteriore 22,5" coppetta metallica

Rear wheel cover 22,5" metallic cap



STAFFE PER DISCHI - BRACKETS FOR WHEEL COVERS

Staffe per l'applicazione dei dischi in plastica per tutti i tipi di ruote anteriori e posteriori da 16" a 22,5". Per la scelta del tipo di staffa si consiglia di contattare il servizio clienti o compilare il modulo specifico allegato al catalogo

Brackets for the application of Plastic wheel covers for all types from 16" to 22,5" front and rear wheels. For choosing the type of bracket it is recommended to contact customer service or fill in the specific form attached to the catalog



Disco Sirio 22,5" - Sirio wheel cover 22,5"

	MATERIAL	ABS
	SURFACE	RAL 7042
	WEIGHT	1,800 kg

**421003H** ON DEMAND

Disco anteriore 22,5" coppetta Vinci piccola



Front wheel cover 22,5" small Vinci cap

421004H ON DEMAND

Disco posteriore 22,5" coppetta Vinci piccola

Rear wheel cover 22,5" small Vinci cap

READY TO PAINT

	MATERIAL	ABS
	SURFACE	RAL 7042
	WEIGHT	1,800 kg

**421001H** ON DEMAND

Disco anteriore 22,5" coppetta Vinci grande



Front wheel cover 22,5" large Vinci cap

421002H ON DEMAND

Disco posteriore 22,5" coppetta Vinci grande

Rear wheel cover 22,5" large Vinci cap

READY TO PAINT

	MATERIAL	ABS
	SURFACE	RAL 7042
	WEIGHT	1,800 kg

**421005H** ON DEMAND

Disco anteriore 22,5" coppetta metallica

Front wheel cover 22,5" metallic cap



421006H ON DEMAND

Disco posteriore 22,5" coppetta metallica

Rear wheel cover 22,5" metallic cap

READY TO PAINT



Dischi 6 fori - 6 holes rims

	MATERIAL	STAINLESS STEEL
	SURFACE	POLISHED
	WEIGHT	0,70 kg

**4649602****ON DEMAND**

Disco 6 fori, interasse 170 mm

6 holes rim, c.t.c. distance 170 mm





	MATERIAL	STEEL
	SURFACE	BLACKPAINTED
	WEIGHT	0,71 kg

**4649605****ON DEMAND**

Disco 6 fori, interasse 170 mm

6 holes rim, c.t.c. distance 170 mm

Dischi 8 fori - 8 holes rims



	MATERIAL	STAINLESS STEEL
	SURFACE	POLISHED
	MIN. ORDER	20 pcs
	UNIT	10 pcs
	WEIGHT	0,997 kg

**4634202**

Disco 8 fori, interasse 275 mm

8 holes rim, c.t.c. distance 275 mm

Dischi 8 fori - 8 holes rims





	MATERIAL	STEEL
	SURFACE	BLACK PAINTED
	WEIGHT	1,100 kg

**4634205****ON DEMAND**

Disco 8 fori, interasse 275 mm

8 holes rim, c.t.c. distance 275 mm

Dischi 10 fori - 10 holes rims



	MATERIAL	STAINLESS STEEL
	SURFACE	POLISHED
	MIN. ORDER	24 pcs
	UNIT	12 pcs
	WEIGHT	1,329 kg



4650002
ex 4633302

Disco 10 fori, interasse 335 mm
fori staffa Ø 24 mm

10 holes rim, c.t.c. distance 335 mm
hole bracket Ø 24 mm





	MATERIAL	STEEL
	SURFACE	BLACK PAINTED
	MIN. ORDER	24 pcs
	UNIT	12 pcs
	WEIGHT	1,270 kg



465000B
ex 4633305

Disco 10 fori, interasse 335 mm
fori staffa Ø 24 mm

10 holes rim, c.t.c. distance 335 mm
hole bracket Ø 24 mm



	MATERIAL	STAINLESS STEEL
	SURFACE	POLISHED
	MIN. ORDER	24 pcs
	UNIT	12 pcs
	WEIGHT	1,310 kg



4650072
ex 4633312

Disco 10 fori, interasse 335 mm
fori staffa Ø 32 mm

10 holes rim, c.t.c. distance 335 mm
hole bracket Ø 32 mm

	MATERIAL	STEEL
	SURFACE	RED PAINTED
	WEIGHT	1,270 kg





465000L
ex 4633309

ON DEMAND

Disco 10 fori, interasse 335 mm
fori staffa Ø 24 mm

10 holes rim, c.t.c. distance 335 mm
hole bracket Ø 24 mm



anelli 6 fori - 6 holes rings

	MATERIAL	STAINLESS STEEL
	SURFACE	POLISHED
	WEIGHT	0,70 kg

**4634052****ON DEMAND**

Anello 6 fori, interasse 205 mm
foro centrale Ø 135 mm

6 holes ring, c.t.c. distance 205 mm
centre hole Ø 135 mm





	MATERIAL	STEEL
	SURFACE	BLACK PAINTED
	WEIGHT	0,70 kg

**463405B****ON DEMAND**

Anello 6 fori, interasse 205 mm
foro centrale Ø 135 mm

6 holes ring, c.t.c. distance 205 mm
centre hole Ø 135 mm





anelli 8 fori - 8 holes rings

	MATERIAL	STAINLESS STEEL
	SURFACE	POLISHED
	MIN. ORDER	20 pcs
	UNIT	10 pcs
	WEIGHT	1,84 kg

**4638002**

Anello 8 fori, interasse 275 mm
fori staffa Ø 24 mm

8 holes ring, c.t.c. distance 275 mm
bracket Ø 24 mm

	MATERIAL	STEEL
	SURFACE	BLACK PAINTED
	MIN. ORDER	20 pcs
	UNIT	10 pcs
	WEIGHT	0,84 kg

**463801B**

Anello 8 fori, interasse 275 mm
fori staffa Ø 24 mm

8 holes ring, c.t.c. distance 275 mm
bracket Ø 24 mm

anelli 8 fori - 8 holes rings

463801G**ON DEMAND**

Anello 8 fori, interasse 275 mm
fori staffa Ø 24 mm

8 holes ring, c.t.c. distance 275 mm
bracket Ø 24 mm



MATERIAL STEEL



SURFACE SILVER PAINTED



WEIGHT 0,84 kg





anelli 10 fori - 10 holes rings

	MATERIAL	STAINLESS STEEL
	SURFACE	POLISHED
	MIN. ORDER	24 pcs
	UNIT	12 pcs
	WEIGHT	1,05 kg

**4650012** ex 4633002

Anello 10 fori, interasse 335 mm
fori staffa Ø 24 mm



10 holes ring, c.t.c. distance 335 mm
bracket Ø 24 mm

	MATERIAL	STAINLESS STEEL
	SURFACE	POLISHED
	MIN. ORDER	24 pcs
	UNIT	12 pcs
	WEIGHT	1,035 kg

**4650062** ex 4633012

Anello 10 fori, interasse 335 mm
fori staffa Ø 32 mm

10 holes ring, c.t.c. distance 335 mm
bracket Ø 32 mm





	MATERIAL	STEEL
	SURFACE	BLACK PAINTED
	MIN. ORDER	24 pcs
	UNIT	12 pcs
	WEIGHT	1,38 kg

**465001B** ex 4633005

Disco anello 10 fori, interasse 335 mm
staffa Ø 24 mm

10 holes ring, c.t.c. distance 335 mm
bracket Ø 24 mm

anelli 10 fori - 10 holes rings

	MATERIAL	STEEL
	SURFACE	RED PAINTED
	MIN. ORDER	24 pcs
	UNIT	12 pcs
	WEIGHT	1,150 kg



465001L ex 4633001

Disco anello 10 fori, interasse 335 mm
staffa Ø 24 mm

10 holes ring, c.t.c. distance 335 mm
bracket Ø 32 mm

	MATERIAL	STEEL
	SURFACE	SILVER PAINTED
	WEIGHT	1,150 kg







465001G ex 4633001T

ON DEMAND



Disco anello 10 fori, interasse 335 mm
staffa Ø 24 mm

10 holes ring, c.t.c. distance 335 mm
bracket Ø 32 mm

Dischi Supertir 10 fori - 10 holes Supertir rims

	MATERIAL	STAINLESS STEEL
	SURFACE	POLISHED
	MIN. ORDER	24 pcs
	UNIT	12 pcs
	WEIGHT	1,35 kg

**4650022** ex 4635702Disco Supertir 10 fori, interasse 335 mm
staffa Ø 24 mmSupertir rim 10 holes,
c.t.c. distance 335mm
bracket Ø 24 mm

	MATERIAL	STAINLESS STEEL
	SURFACE	POLISHED
	WEIGHT	1,20 kg

**4650082**
ex 4635722**ON DEMAND**Disco Supertir 10 fori, interasse 335 mm
staffa Ø 32 mmSupertir rim 10 holes,
c.t.c. distance 335mm
bracket Ø 32 mm

Accessori per dischi copriruota - Accessories for wheel covers

	MATERIAL	PC-ABS
	COLOR	BLACK
	MIN. ORDER	32 pcs
	UNIT	16 pcs
	WEIGHT	0,086 kg

**4051505**

Coppetta centrale Vinci piccola

Small Vinci central cap

STEEL WHEELS

ALLOY WHEELS

KEY 27

404830x



KEY 30

404820x



KEY 32

404810x



4048603



KEY 32/33

404884x



404880x

404884x







KEY 33

404800x







Copribullone Ch27 - Nutcover Key 27

	MATERIAL	ABS
	SURFACE	CHROMED
	MIN. ORDER	360 pcs
	UNIT	360 pcs
	WEIGHT	0,008 kg

**4048303**

Copribullone chiave 27 esagonale

Nutcover key 27

	MATERIAL	ABS
	SURFACE	BLACK
	MIN. ORDER	360 pcs
	UNIT	360 pcs
	WEIGHT	0,006 kg

**4048305**



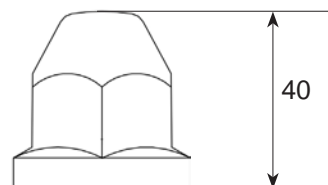
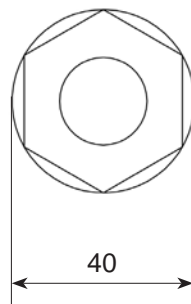

Copribullone chiave 27 esagonale

Nutcover key 27

DIMENSIONI - DIMENSIONS







Copribullone Ch30 - Nutcover Key 30

	MATERIAL	ABS
	SURFACE	CHROMED
	MIN. ORDER	420 pcs
	UNIT	420 pcs
	WEIGHT	0,012 kg



4048203

Copribullone chiave 30 esagonale
Nutcover key 30

	MATERIAL	ABS
	SURFACE	BLACK
	MIN. ORDER	420 pcs
	UNIT	420 pcs
	WEIGHT	0,011 kg





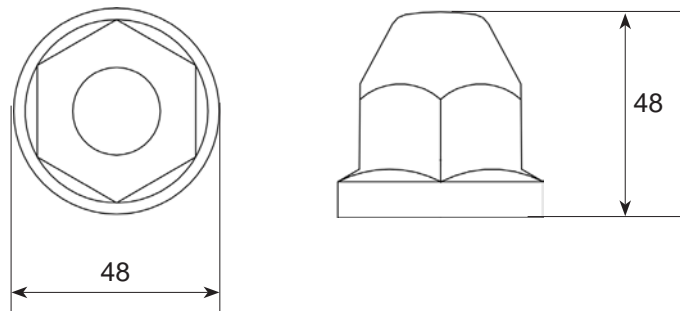

4048205

Copribullone chiave 30 esagonale
Nutcover key 30

DIMENSIONI - DIMENSIONS







Copribullone Ch32 - Nutcover Key 32

	MATERIAL	ABS
	SURFACE	CHROMED
	MIN. ORDER	420 pcs
	UNIT	420 pcs
	WEIGHT	0,014 kg

**4048103**

Copribullone chiave 32 esagonale



Nutcover key 32

	MATERIAL	ABS
	SURFACE	BLACK
	MIN. ORDER	420 pcs
	UNIT	420 pcs
	WEIGHT	0,013 kg

**4048105**

Copribullone chiave 32 esagonale

Nutcover key 32

	MATERIAL	ABS
	SURFACE	RED
	WEIGHT	0,013 kg

**4048100****ON DEMAND**



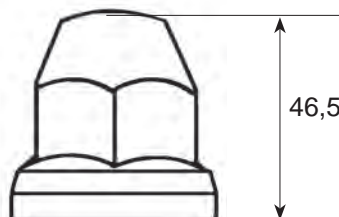
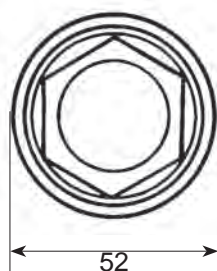

Copribullone chiave 32 esagonale

Nutcover key 32

DIMENSIONI - DIMENSIONS



Copribullone Ch32 - Nutcover Key 32

	MATERIAL	ABS
	SURFACE	CHROMED
	MIN. ORDER	420 pcs
	UNIT	420 pcs
	WEIGHT	0,017 kg

**4048603**Copribullone chiave 32 esagonale
per ruote in lega



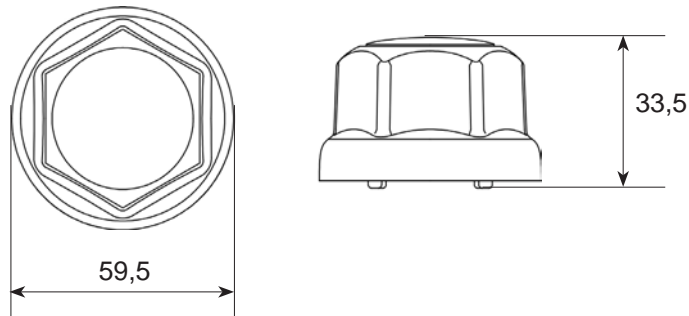

Nutcover key 32 for alloy wheels

**PER RUOTE IN LEGA
FOR ALLOY WHEELS**

DIMENSIONI - DIMENSIONS



Testa piatta Ch32/33 - Flat head 32/33



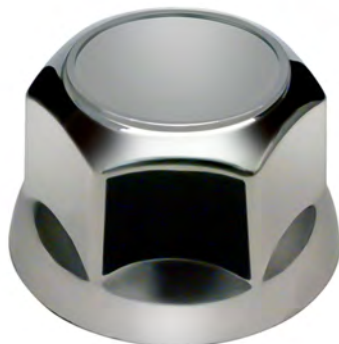

	MATERIAL	PC-ABS
	SURFACE	CHROMED
	MIN. ORDER	480 pcs
	UNIT	160 pcs
	WEIGHT	0,023 kg

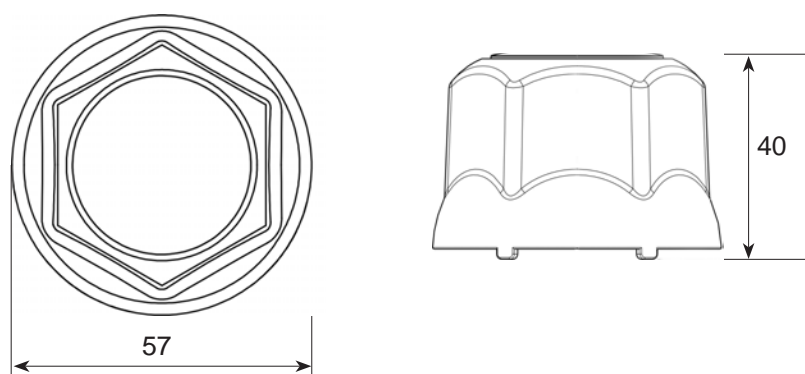
**4048840**Copribullone chiave 32/33
con testa piatta h 40 mmNutcover key 32/33 with flat head
h 24 mm**PER RUOTE IN LEGA
FOR ALLOY WHEELS**

DIMENSIONI - DIMENSIONS



Testa bombata Ch32/33 - Rounded head 32/33

	MATERIAL	PC-ABS
	SURFACE	CHROMED
	MIN. ORDER	480 pcs
	UNIT	160 pcs
	WEIGHT	0,023 kg

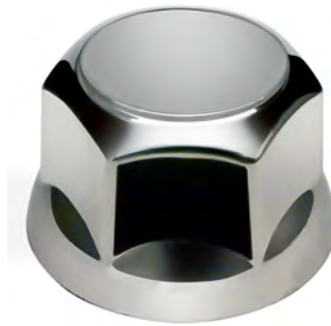
**4048800**

Copribullone per cerchi in lega chiave 32/33 con testa bombata h 42 mm



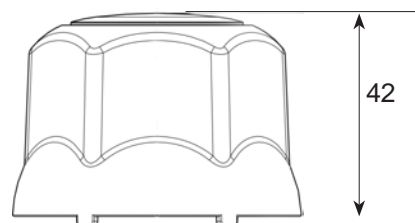
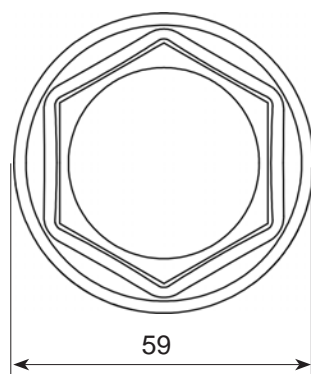

Nutcover for aluwheel key 32/33 with rounded head h 42 mm

**PER RUOTE IN LEGA
FOR ALLOY WHEELS**

DIMENSIONI - DIMENSIONS







Copribullone Ch33 - Nutcover Key 33

	MATERIAL	ABS
	SURFACE	CHROMED
	MIN. ORDER	420 pcs
	UNIT	420 pcs
	WEIGHT	0,016 kg



**4048003**

Copribullone chiave 33 esagonale
Nutcover key 33

	MATERIAL	ABS
	SURFACE	BLACK
	MIN. ORDER	420 PCS
	UNIT	420 PCS
	WEIGHT	0,015 kg

**4048005**

Copribullone chiave 33 esagonale
Nutcover key 33

	MATERIAL	ABS
	SURFACE	RED
	WEIGHT	0,015 kg

**4048000****ON DEMAND**

Copribullone chiave 33 esagonale
Nutcover key 33

DIMENSIONI - DIMENSIONS

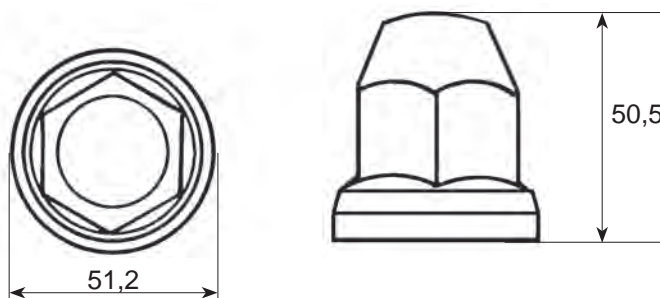

Accessori copribulloni - Nutcover accessories



Contenitore riutilizzabile, con attrezzo per l'estrazione incluso.





Personalizzazione possibile con stampa a 2 o 4 colori.

Reusable box with tool for extractin included.

Customizing possible with 2 or 4 colours print.







Sistema di sicurezza Nut lock - Nut lock safety system

	MATERIAL	ABS-PA
	SURFACE	CHROMED
	MIN. ORDER	120 pcs
	UNIT	120 pcs
	WEIGHT	0,056 kg

**4049100-Y**

Sistema antisvitamento
Nut lock chiave 30





Unscrewing sistem Nut lock
key 30

	MATERIAL	ABS-PA
	SURFACE	BLACK
	MIN. ORDER	120 pcs
	UNIT	120 pcs
	WEIGHT	0,048 kg

**4049100-5**

Sistema antisvitamento
Nut lock chiave 30





Unscrewing sistem Nut lock
key 30

	MATERIAL	ABS-PA
	SURFACE	CHROMED
	MIN. ORDER	120 pcs
	UNIT	120 pcs
	WEIGHT	0,056 kg

**4049102-Y**

Sistema antisvitamento
Nut lock chiave 32

Unscrewing sistem Nut lock
key 32

	MATERIAL	ABS-PA
	SURFACE	BLACK
	MIN. ORDER	120 pcs
	UNIT	120 pcs
	WEIGHT	0,048 kg

**4049102-5**

Sistema antisvitamento
Nut lock chiave 32

Unscrewing sistem Nut lock
key 32

Sistema di sicurezza Nut lock - Nut lock safety system



MATERIAL ABS-PA



SURFACE CHROMED



MIN. ORDER 120 pcs



UNIT 120 pcs



WEIGHT 0,056 kg

**4049103-Y**Sistema antisvitamento
Nut lock chiave 33Unscrewing sistem Nut lock
key 33

MATERIAL ABS-PA



SURFACE BLACK



MIN. ORDER 120 pcs



UNIT 120 pcs



WEIGHT 0,048 kg

**4049103-5**Sistema antisvitamento
Nut lock chiave 33Unscrewing sistem Nut lock
key 33

L'insieme dei componenti montati ad anello, garantiscono l'antisvitamento degli organi di fissaggio, senza successiva manutenzione e creano un nuovo disco copri ruota ad anello, sia per ruote anteriori sia posteriori.

The Nut Lock single components assembled together create a new ring wheel cover, that prevents the unscrewing of the fixing elements. No further maintenance is needed!
Nut Lock can be mounted either on front or rear wheels.



SAFETY
Unscrewing prevention



PROTECTION
Wheel fixing element protection



AESTETIC
Ring wheel cover with a brand-new design



CARACTERISTICS
Body: black or chromed
Cap: pantone 369U



CUSTOMISATION
Nut-Lock's cap can be tailored with an embossed logo



LIGHTNESS
It weighs only 50 g!



KEYS
30 - 32 - 33
9.5" , 22.5" wheel rims



MAINTENANCE
No further maintenance needed



Front wheel



Rear wheel

- I dadi delle ruote non devono essere danneggiati da nessun segno di ammaccature o abrasioni
- La distanza tra il mozzo della ruota o perni di centraggio e il collare dei dadi non deve essere inferiore a 3 mm
- Non devono esserci valvole o rilevatori di monitoraggio della pressione dei pneumatici (TPMS) nell'area di fissaggio dei bulloni.
- The wheel nuts shall not be damaged (no dents nor abrasions signs)
- The distance between the wheel hub (or centering pins, if present) and the nuts' collar shall not be less than 3 mm
- There must be no valves stems or tire-pressure monitoring detectors (TPMS) in the bolt fixing area where the lug holes are



ASSEMBLY
INSTRUCTIONS