

CITIPRO

Seats for Vehicles



Since 1937



100% made in ITALY



Components





Main Features

MODULARITY

All the elements are easily removable for cleaning or replacement.

CUSTOMIZATION

Wide range of fabrics, plastic materials and colors, USB and LED lights available.

HIGH QUALITY

Long-lasting and recyclable materials.

OPTIONS

Different finishings available.

ANTI-GRAFFITI

Materials conceived with anti graffiti feature.

WIDE APPLICATION

Urban busses, mini busses, boats, trams, subways, waiting rooms, tribunes, cable railways.

CERTIFICATIONS & TESTS

Compliant with EN 45545.2 for PC material & metallic end caps; R118. 02/03 - PA material; R.80 UN/ECE

ANTIBACTERIAL

New PA plastic with antibacterial feature on demand.

RECYCLABLE AND RECYCLED

The seat is completely recyclable.

Dimensions and Weight

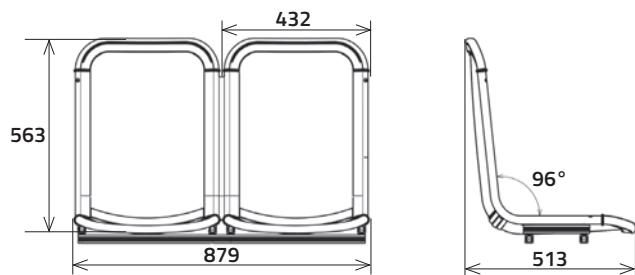

Basic double without handle weight. 9,8 kg
with handle 10,3 kg.

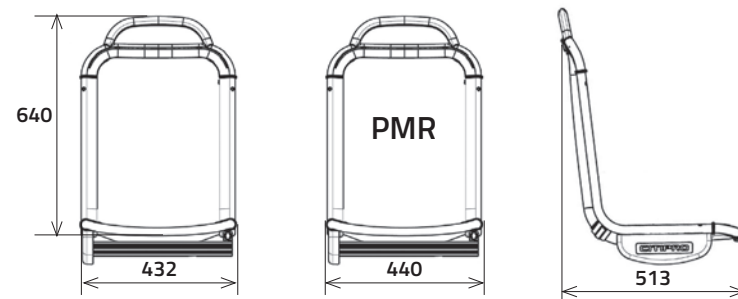

Basic without handle 4,9 kg with handle 5,5 kg.
Pmr without handle 6,0 kg with handle 6,6 kg.

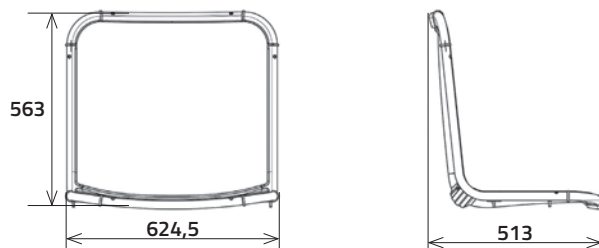

Jumbo without handle weight. 9,5 kg
with handle 9,8 kg.

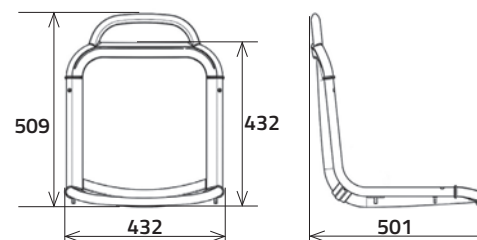

Junior without handle 4,2 kg with handle 4,8 kg.

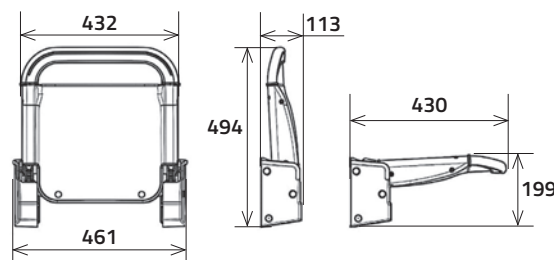

Flip weight 5,7 kg

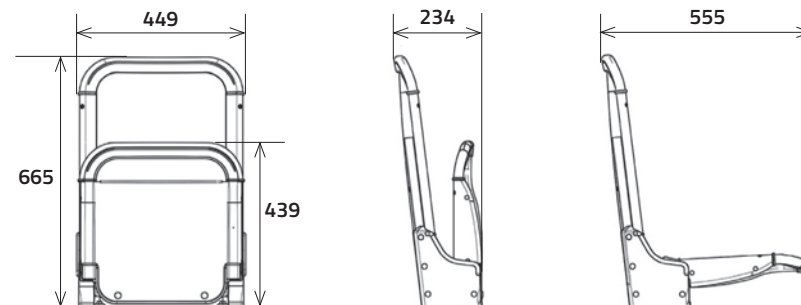

Tip up weight 8,8 kg



Standard Color

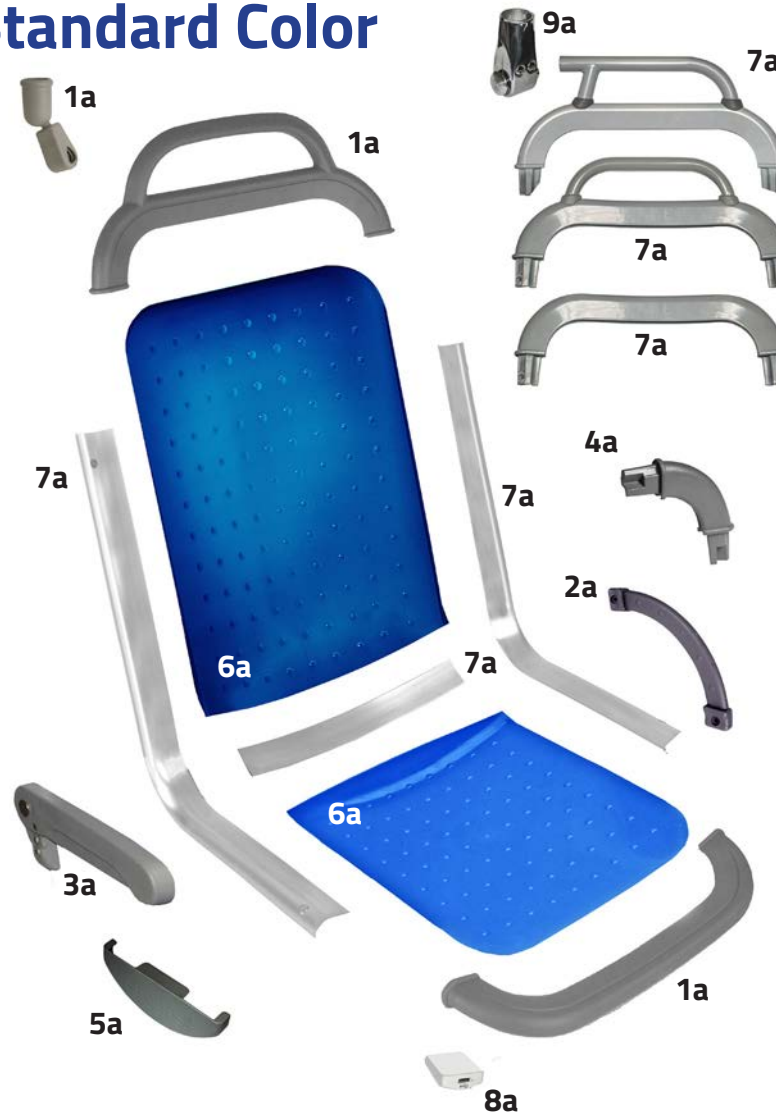

1a Plastic end-cap with and without handle and Stanchion holder

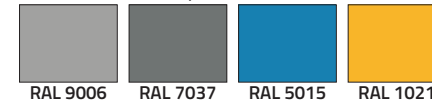

2a Plastic hip containment



3a Armrest

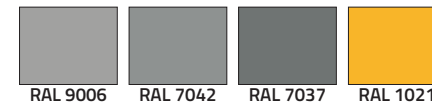

4a Jumbo corner



5a Side cover



6a Seat base and back rest solid color



7a Frame, PMR seat frame addition

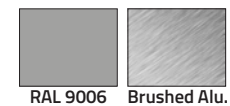

8a USB socket

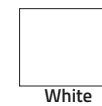

9a Metal stanchion holder

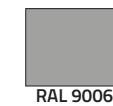

On demand Color (MOQ 150pcs/Color)

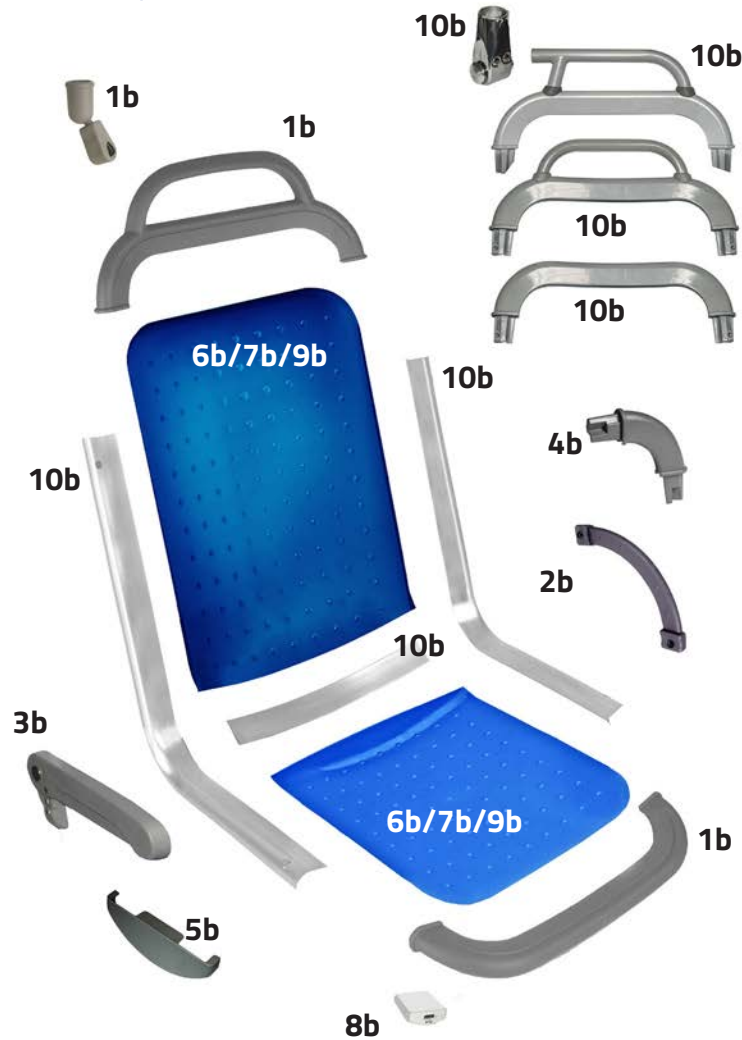

1b Plastic end-cap with and without handle and Stanchion holder

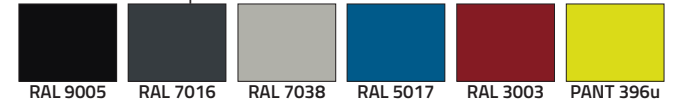

2b Plastic hip containment

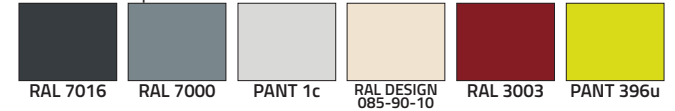

3b Armrest

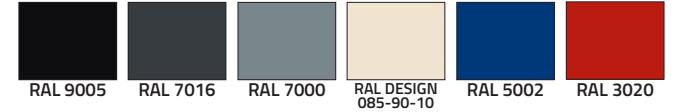

4b Jumbo corner

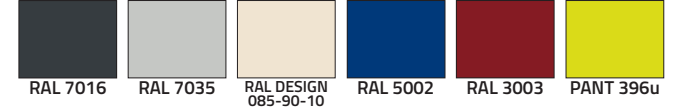

5b Plastic Side cover

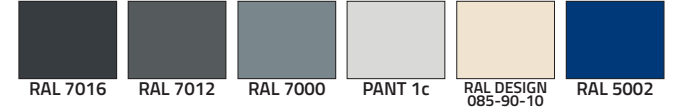

6b Seat base and back rest solid color (PA)

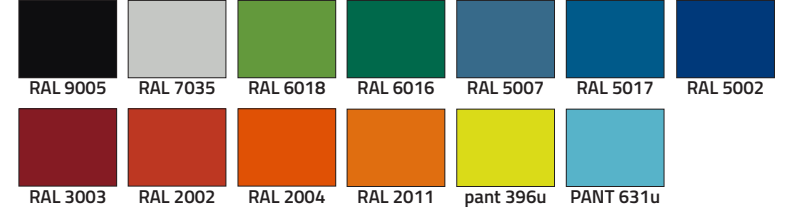

7b Seat base and back rest translucent color PE

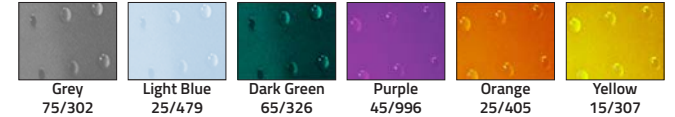

8b USB socket



9b Wood seat base and back rest



10b Metal frame, end-cap, with and without handle and stanchion holder any color available



* priority to colors already done, TBC with our commercial offices

RUSPA

INNOVATION MANUFACTURING

Models



Basic



PMR



Jumbo



Junior



Tip up



Flip



Two, three or more places



Finishing



BASIC
(Plastic insert)



COMFORT LIGHT
(Glued fabric, visible tube)



COMFORT PLUS
(Upholstered fabric, partly covered tube)



COMFORT NORMAL
(Upholstered fabric, visible tube)



WOOD
(Upper and lower end-caps in PA)



New cut resistant option, available on demand

OPTIONS

Standard
USB socket



Waterproof
USB socket



Double seats
USB socket



Equipped with assistive system
for hearing - impaired people



Customized logo or other images



Led lights

Equipped with LED
and USB socket

Accessories



Hip containment



Armrests



Side covers



Safety belt



Stainless steel protection

Totem *



Upholstered panel



Translucent plastic panel



Upholstered panel



BASIC plastic panel with raised dots



Upholstered panel and plastic panel



* See additional details in the specific brochure

Seat Supports



Light model



Design model



Smart model

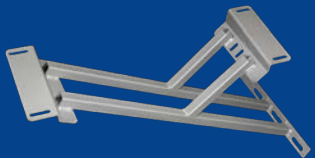

Cantilever

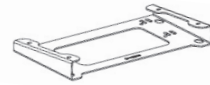
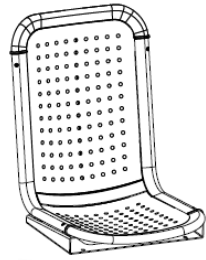

Basic with adapter

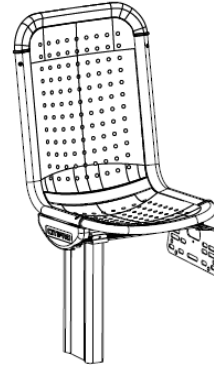

Wall mount, "T" leg

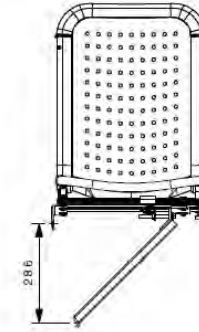

Cantilever frame

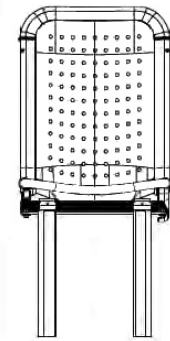

"T" legs

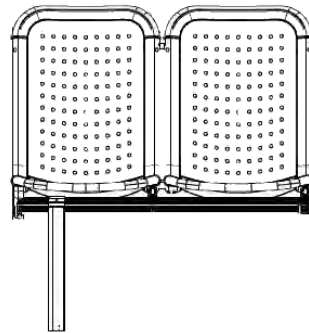

Wall mount, "T" leg

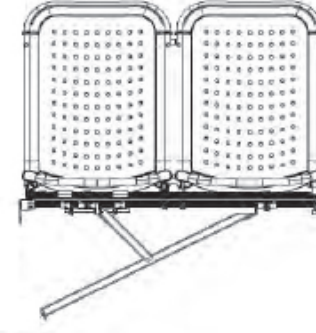

Cantilever frame

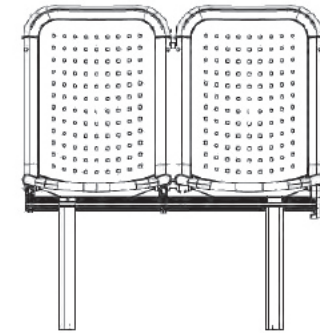

"T" legs

Some of our projects



Urban vehicle



Electric urban vehicle



Some of our projects



Boats



Open tour



Cable cars



Urban vehicle



RUSPA

INNOVATION MANUFACTURING

Fondata nel 1937, Ruspa Officine è un 'azienda indipendente che non controlla e non è controllata da altre imprese.

Nel corso degli anni, ha sviluppato il proprio core business progettando e producendo equipaggiamenti speciali e componenti per il settore dei veicoli commerciali (trasporto di merci e persone).

Founded in 1937, Ruspa Officine is an independent company that does not control and is not controlled by other companies.

Over the years, it has developed its core business by designing and manufacturing special equipment and components for the commercial vehicle sector (transport of goods and people).

